

Baltic 165 Maamess//150/22

Baltic 16S Maamess//50/22

3900

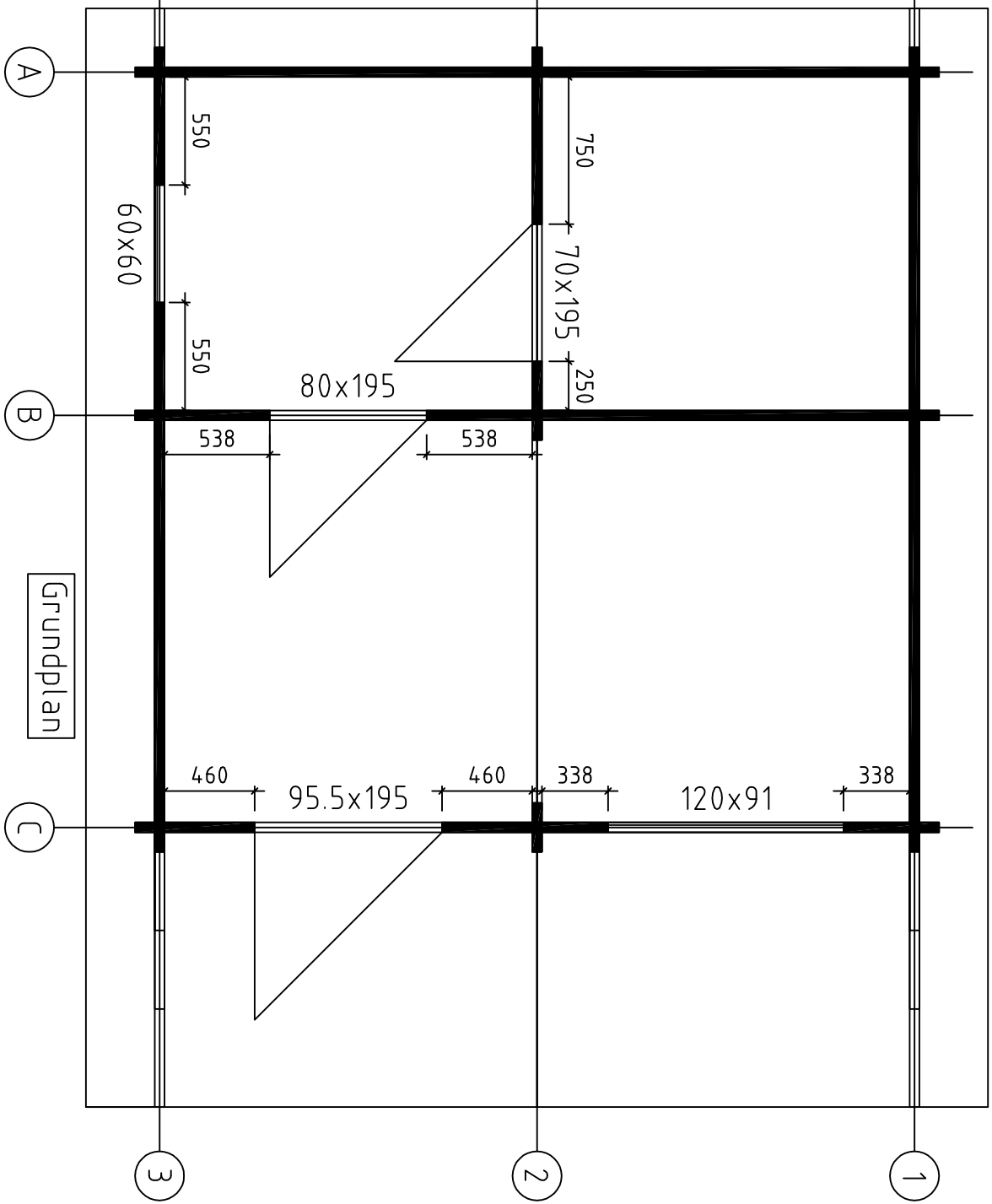
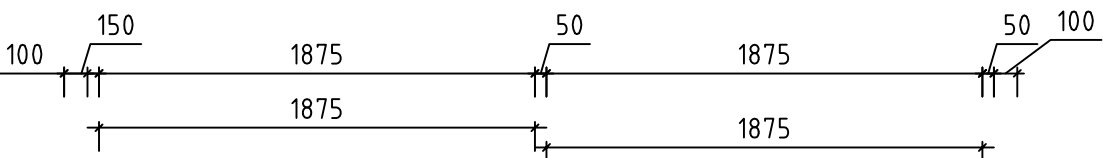
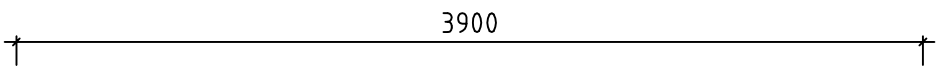
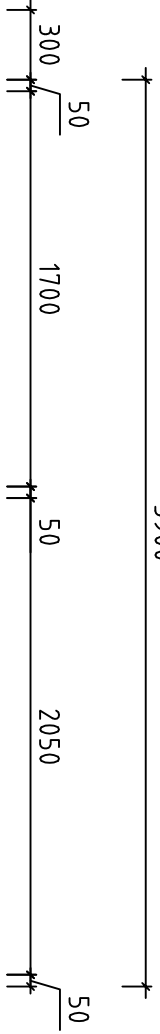

Grundplan

Baltic 16S Maamess//50/22

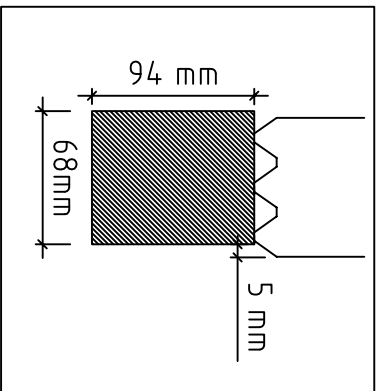
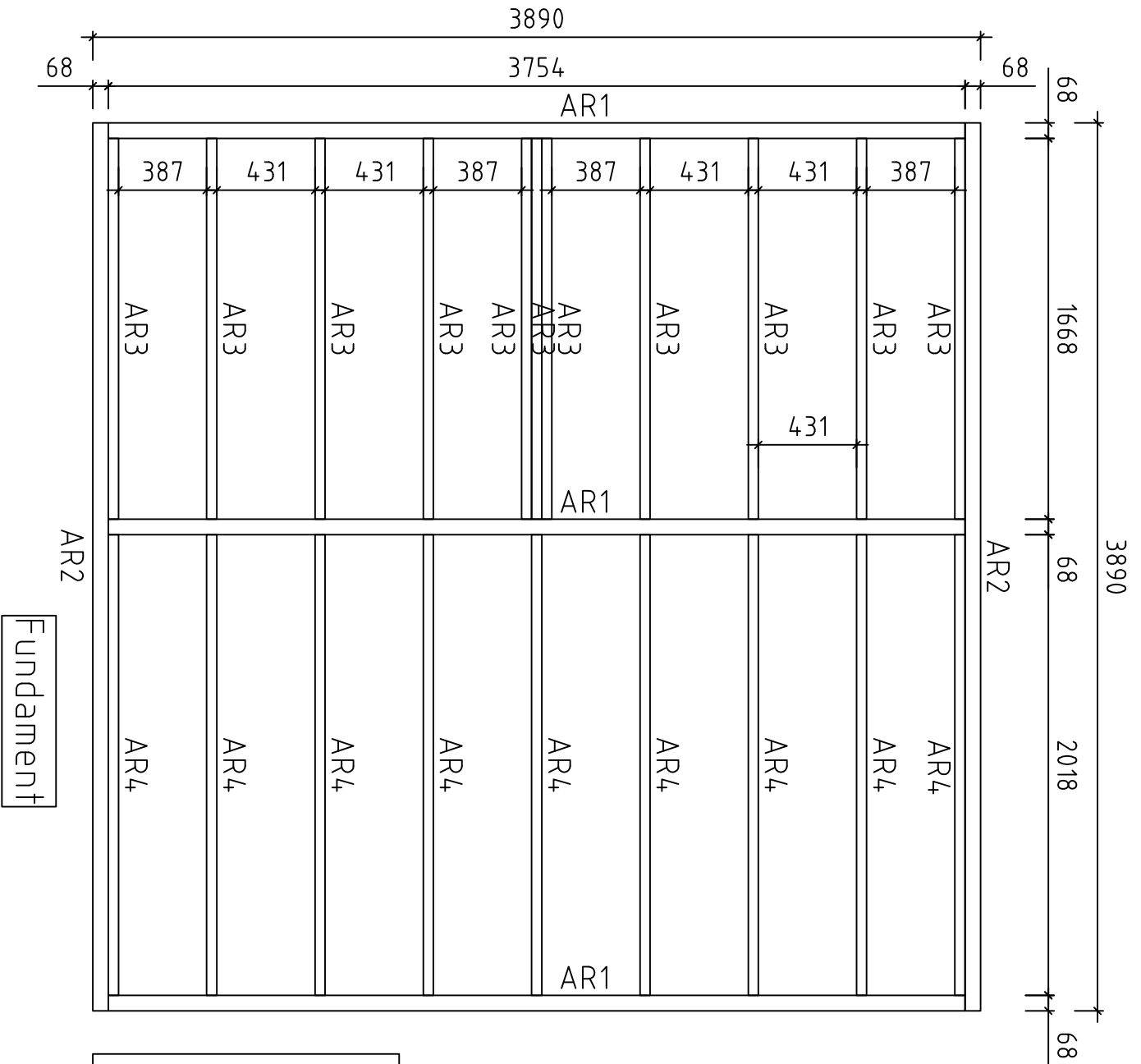

Wand 1 ↗

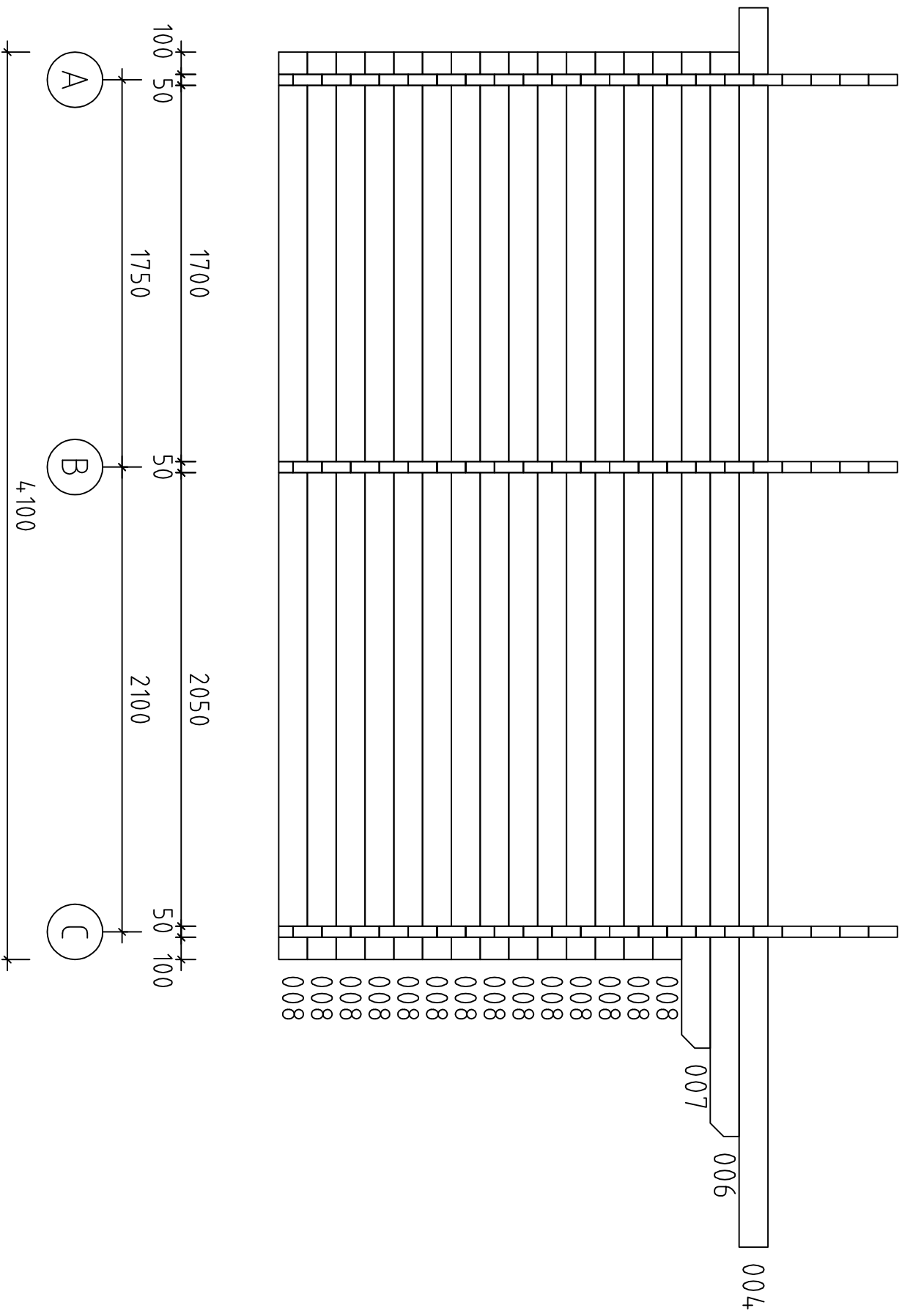

Baltic 16S Maamess // 50 / 22

Wand 2 ↗

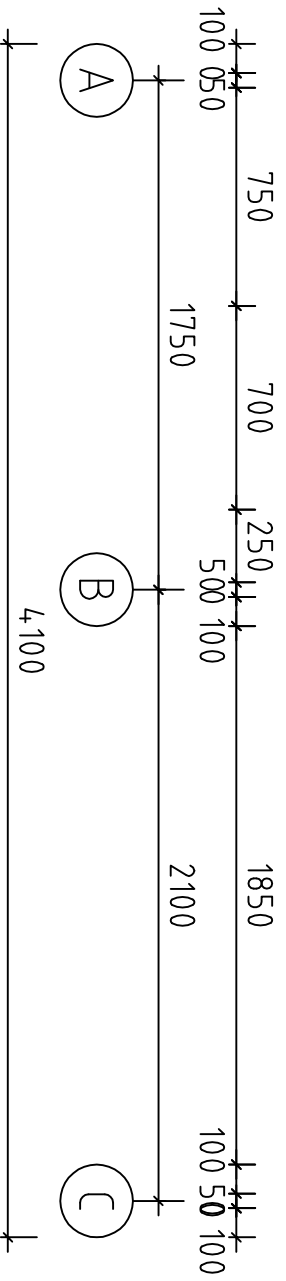
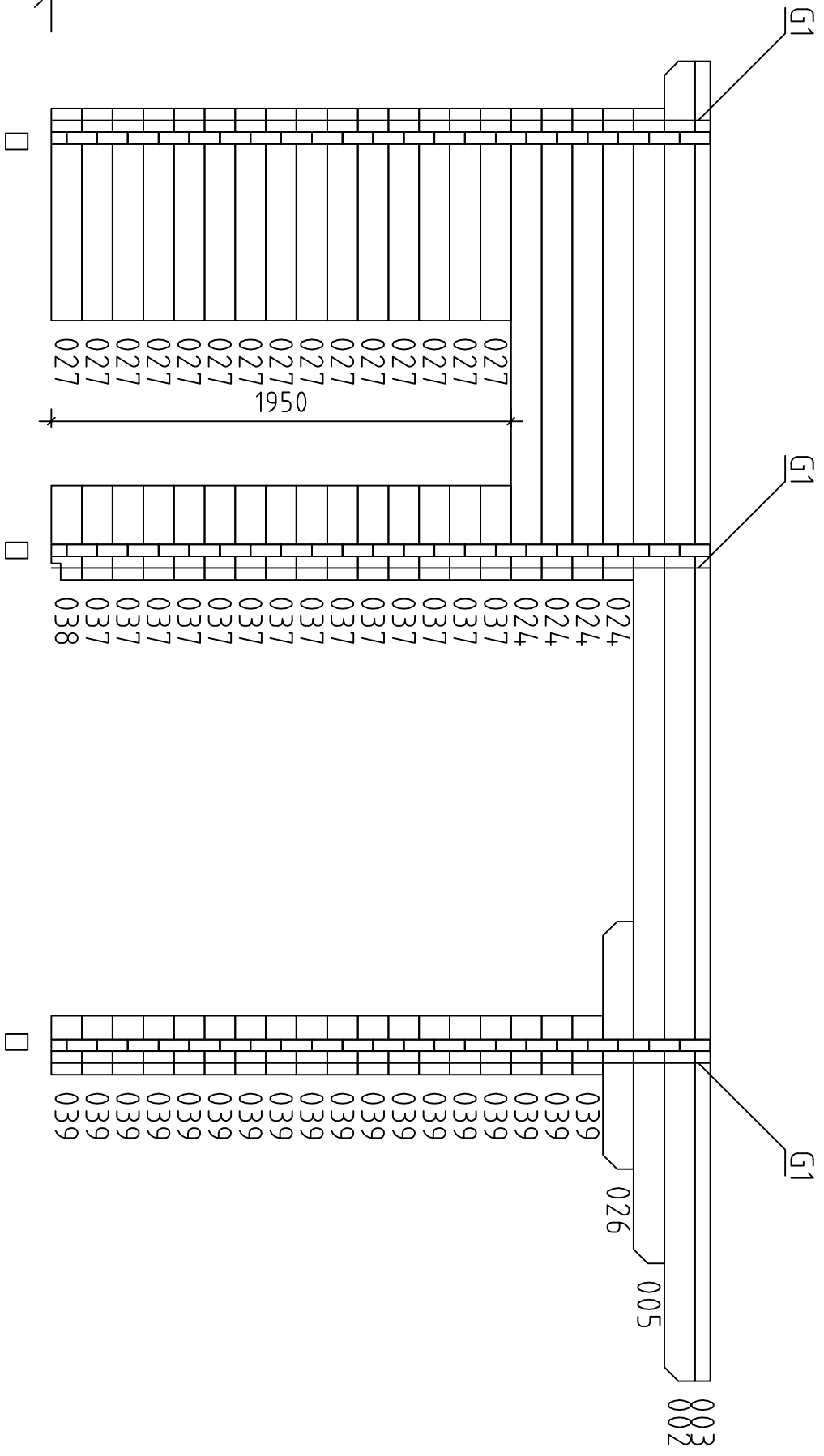

Baltic 16S Maamess//50/22



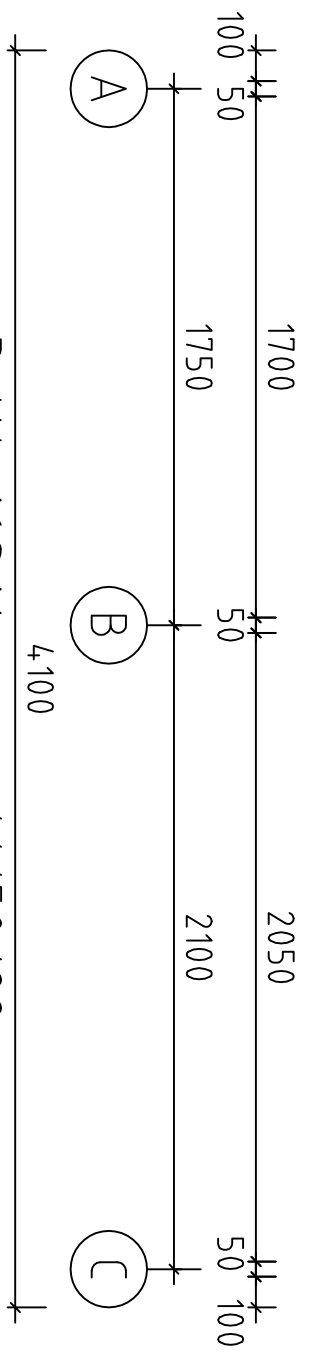
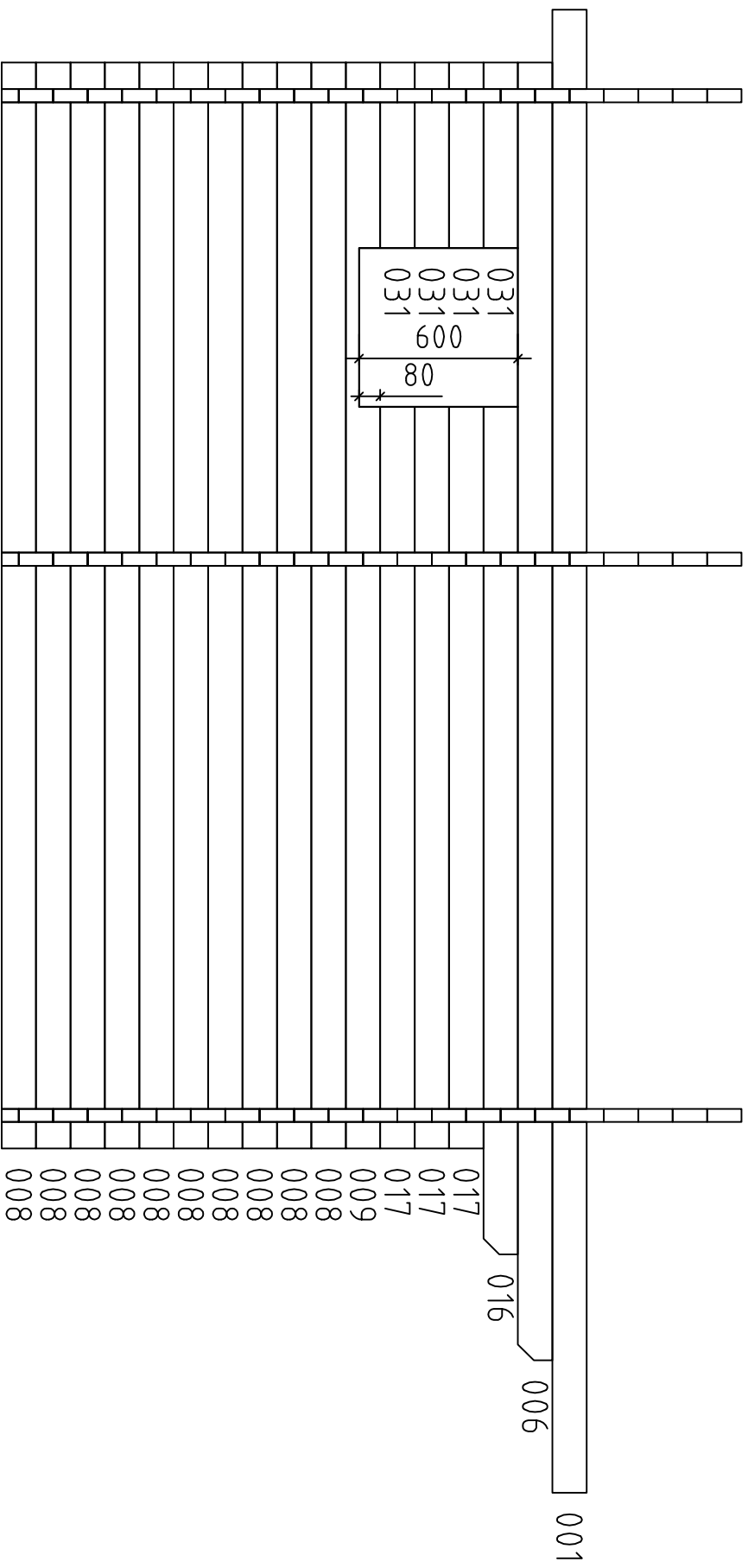

Wand 3 ↗

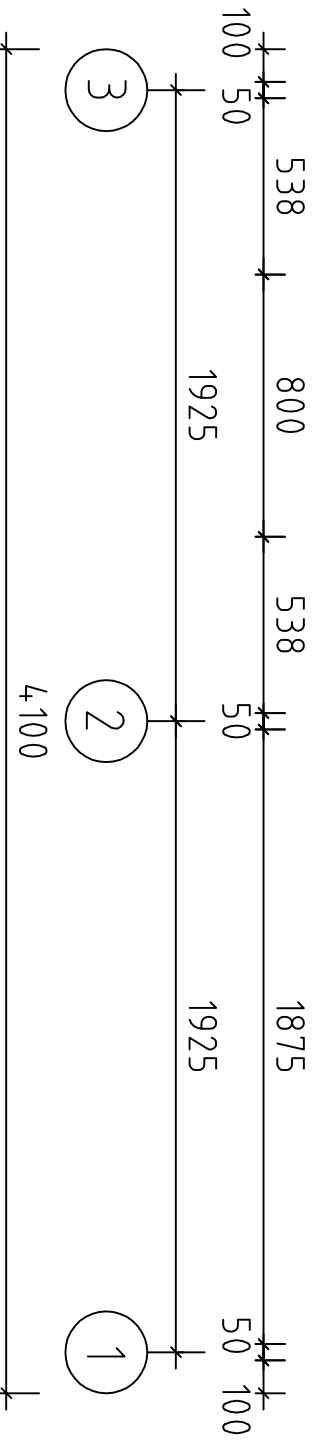
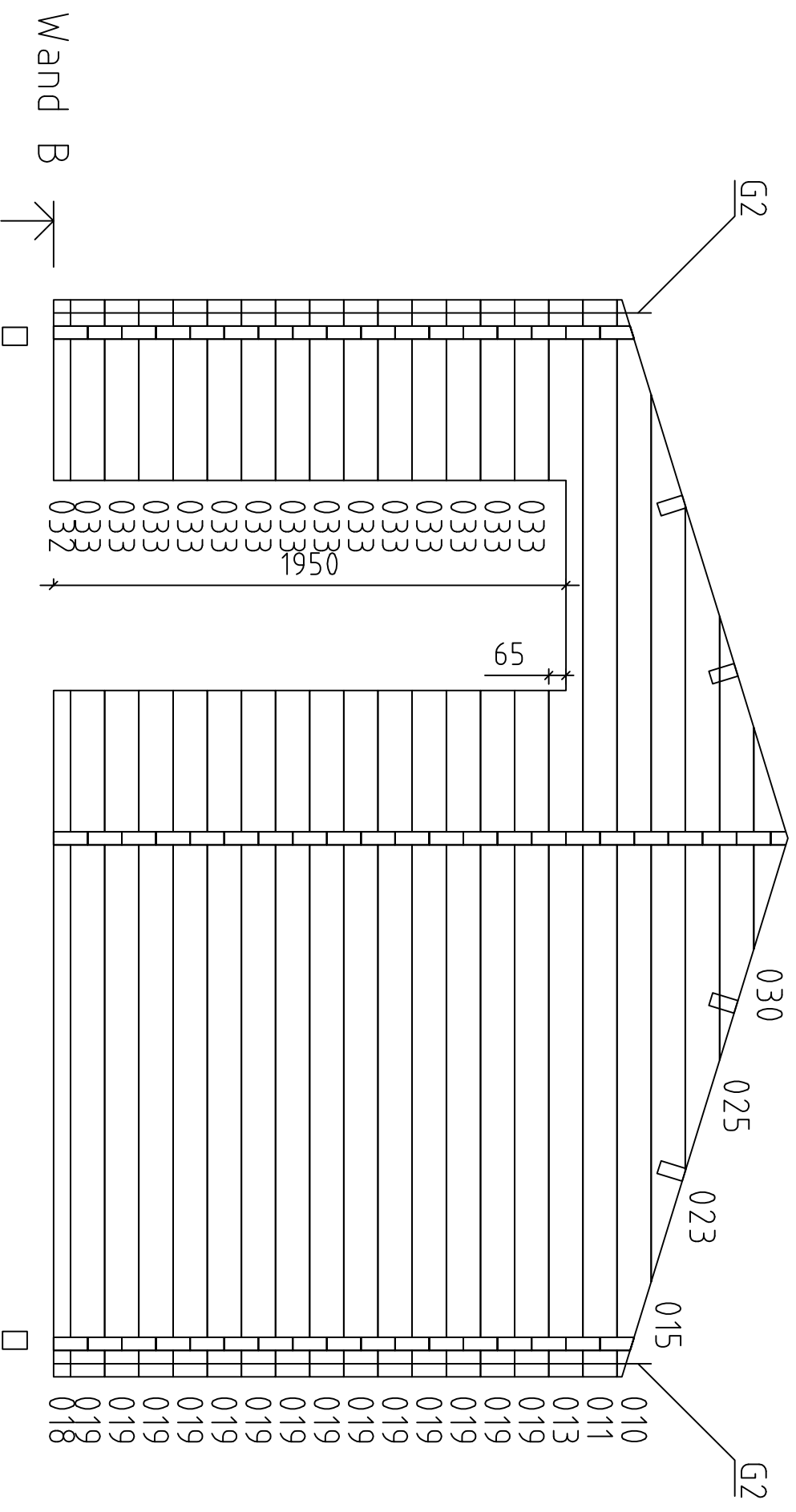



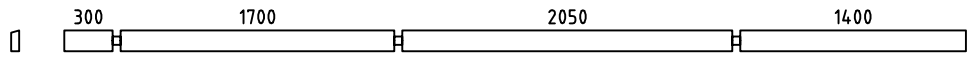
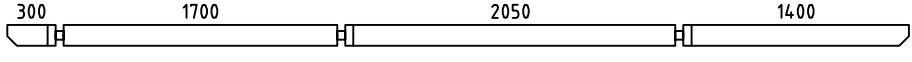
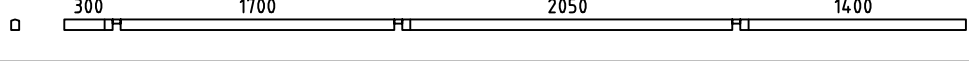
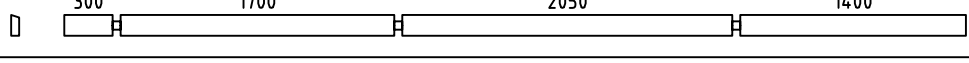
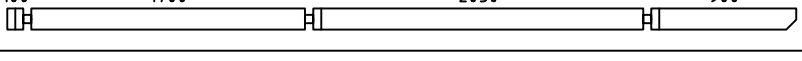
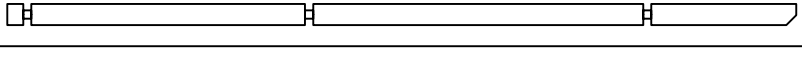
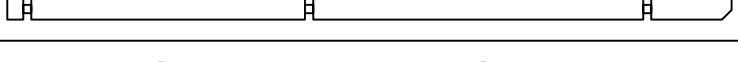

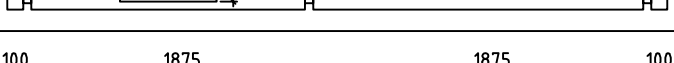
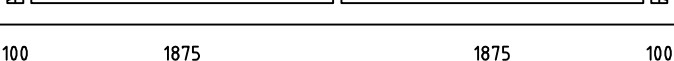
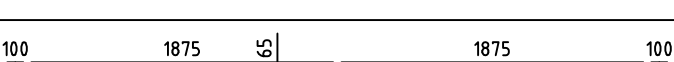
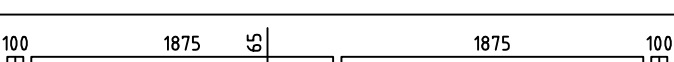

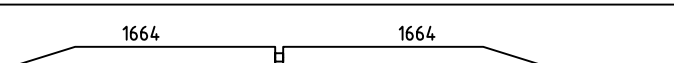
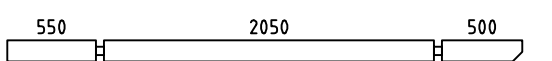
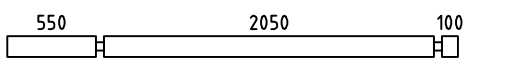
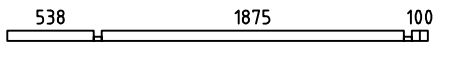
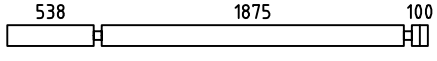
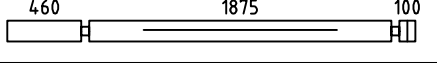
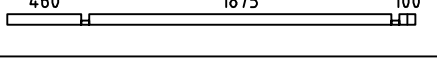
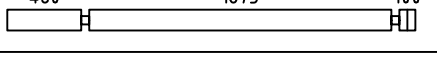
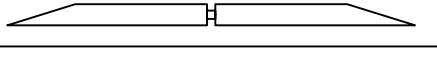
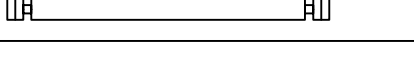
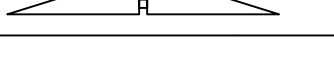

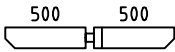
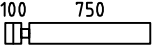
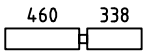
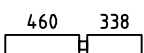
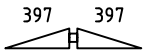
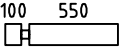
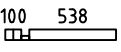
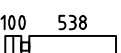
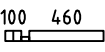
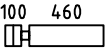

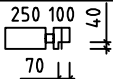

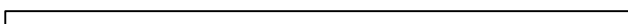
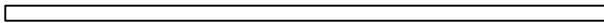
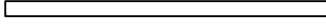
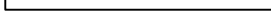
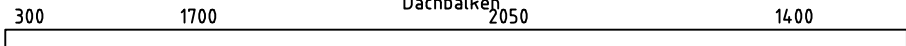

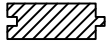

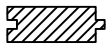



Baltic 16S Maamess//50/22

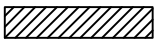

Baltic 16S Maamess//50/22

Pos	Baltic 16S Maames//50/22	ST	F (mm)	L (mm)
001		1	50x130	5600
002		1	50x130	5600
003		1	50x65	5600
004		1	50x130	5600
005		1	50x130	4900
006		2	50x130	4900
007		1	50x130	4500
008		24	50x130	4100
009		1	50x130	4100
010		3	50x130	4100
011		18	50x130	4100
012		1	50x130	4100
013		1	50x130	4100
014		1	50x65	4100
015		3	50x130	3378
016		1	50x130	3200
017		3	50x130	2800
018		1	50x65	2612
019		14	50x130	2612
020		1	50x130	2535
021		1	50x65	2535
022		6	50x130	2535
023		3	50x130	2533
024		4	50x130	2000
025		3	50x130	1689

Pos	Baltic 16S Maamess///50/22	ST	F (mm)	L (mm)	
026		1	50x130	1050	
027		15	50x130	900	
028		1	50x130	848	
029		6	50x130	848	
030		3	50x122	844	
031		4	50x130	700	
032		1	50x65	688	
033		14	50x130	688	
034		1	50x65	610	
035		14	50x130	610	
036		7	50x130	488	
037		14	50x130	400	
038		1	50x130	400	
039		18	50x130	250	
AR2	Fundamentbalken 	impr.	2	68x94	3890
AR1	Fundamentbalken 	impr.	3	68x94	3754
AR4	Fundamentbalken 	impr.	9	44x94	2018
AR3	Fundamentbalken 	impr.	11	44x94	1668
PR1	Dachbalken 		4	45x140	5600

Pos	Baltic 16S Maames//50/22		ST	F (mm)	L (mm)
040	Fussbodenbretter		24	90x26	3796
041	Fussbodenbretter	värvitud! 	19	90x26	1871
042	Fussbodenbretter	värvitud! 	19	90x26	1852
043	Dachbretter		126	90x20	2400
044	Innendachbretter (leiliruum)		19	90x20	1950
045	Abdeckleiste			20x40	80m
046	Giebelbretter		4	20x120	2700
047	Giebelbretter		4	20x90	2700
048	Giebeldeckbretter		8	20x70	2700
049	Traufenbretter		2	20x90	5700
050	Träger für Traufenbretter		4	50x50	2850
051	Giebelsegment		2		
052	Träger für Innendachbretter		2	50x50	1700
053	Hitblock 300....400		2		
054	Träger (saunalavale)		4	70x140	1900
G1	Gewindestift 12		3		2815
G2	Gewindestift 12		6		2295
KMPL		für Fundament	40	60x60x60	
	Schrauben	für Fundament	350	4,5x40	
	Schrauben+Dübel (lööktüübel)	für Fundament	25	8x160	
	Schrauben	für Wand, Giebel, Dachbalken	80	5x120	
	Schrauben	für Leisten usw.	150	4x50	
	Nägel	für Fussboden und Dach	2kg	2,5x60	

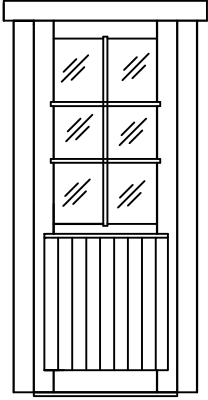
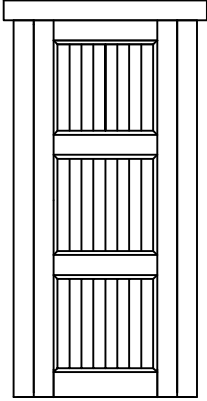
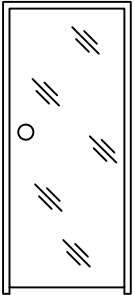
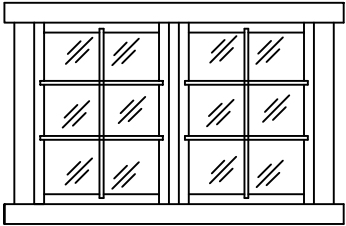
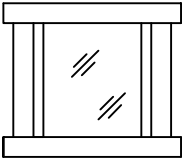
Pos	Baltic 16S Maamess///50/22	ST	F (mm)	L (mm)				
T1	Tür 955x1950  <table border="1" data-bbox="614 219 1013 313"> <tr> <td>Iso</td> <td>970x690</td> </tr> <tr> <td></td> <td>kotike 1 kmpl.</td> </tr> </table>	Iso	970x690		kotike 1 kmpl.	1L		
Iso	970x690							
	kotike 1 kmpl.							
T2	Tür 800x1950  <table border="1" data-bbox="561 741 963 790"> <tr> <td></td> <td>kotike 1 kmpl.</td> </tr> </table>		kotike 1 kmpl.	1L				
	kotike 1 kmpl.							
T3	Tür 700x1950  <p>Jäab alt lahti !!</p>	1R						
F1	Fenster 1200x910  <table border="1" data-bbox="651 1626 1051 1720"> <tr> <td>Iso</td> <td>672x442=2st.</td> </tr> <tr> <td>Blech</td> <td>45x495= 2st.</td> </tr> </table>	Iso	672x442=2st.	Blech	45x495= 2st.	1		
Iso	672x442=2st.							
Blech	45x495= 2st.							
F2	Fenster 600x600  <table border="1" data-bbox="684 1984 1085 2078"> <tr> <td>Iso</td> <td>398x362</td> </tr> <tr> <td>Blech</td> <td></td> </tr> </table>	Iso	398x362	Blech		1R		
Iso	398x362							
Blech								