

Art. Nr. 2854494
1/6

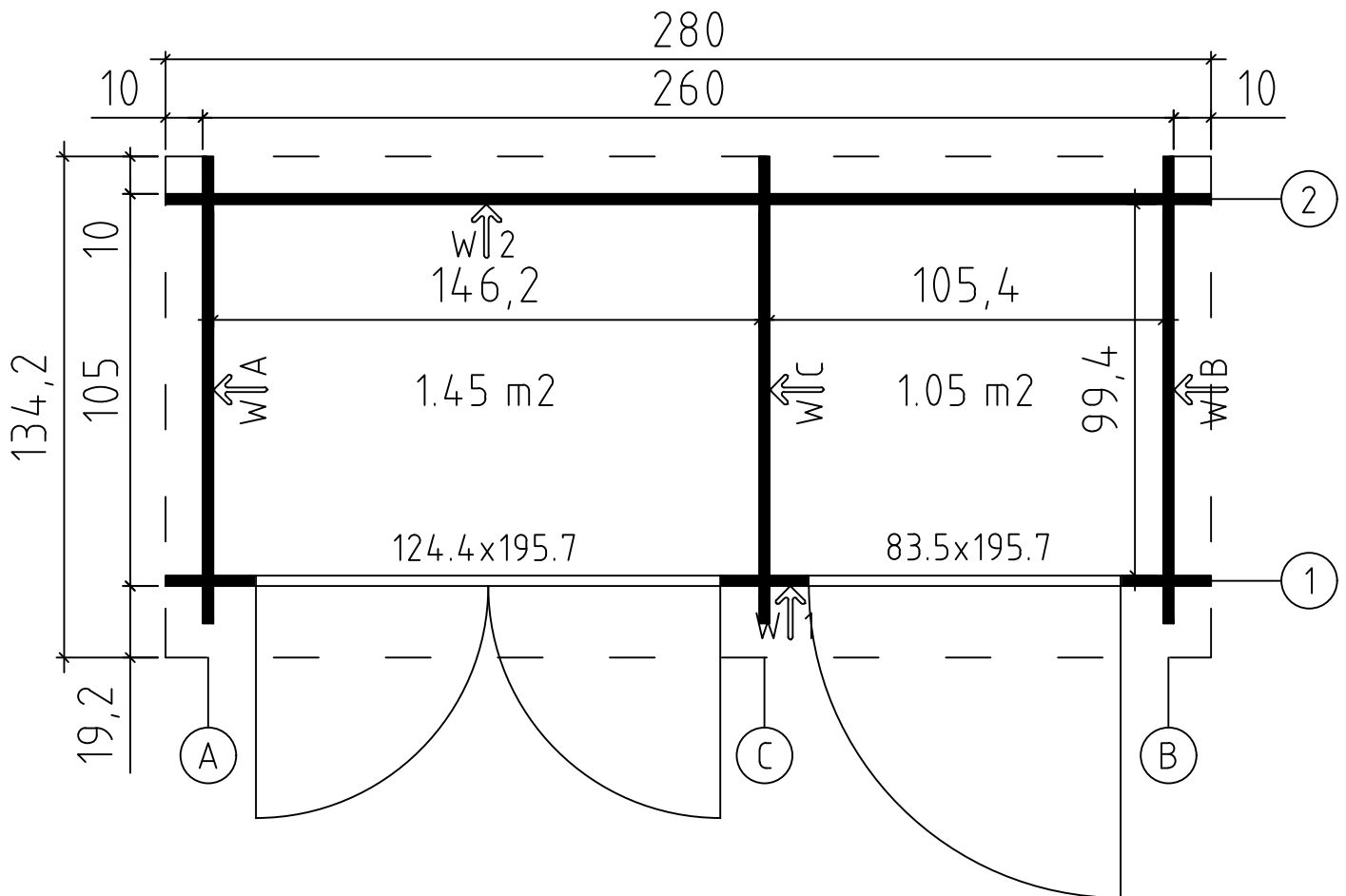

10.01.2023

Groundplan - Grundplan - Plan de masse -
Planimetria - Plattegrond - Põhiplaan



Art. Nr. 2854494

Without tongue - Ohne feder - Madrier de finition -
 Finale in leqño - Zonder veer - Punnita

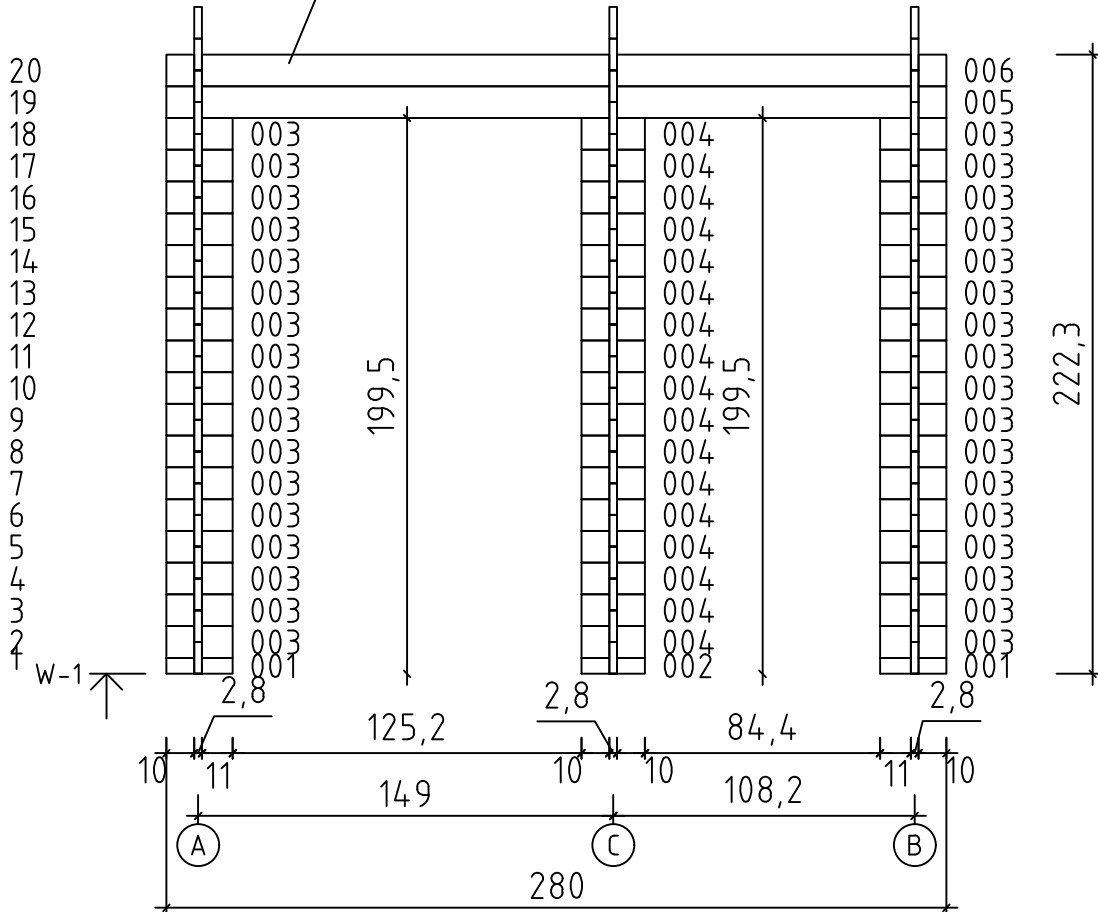



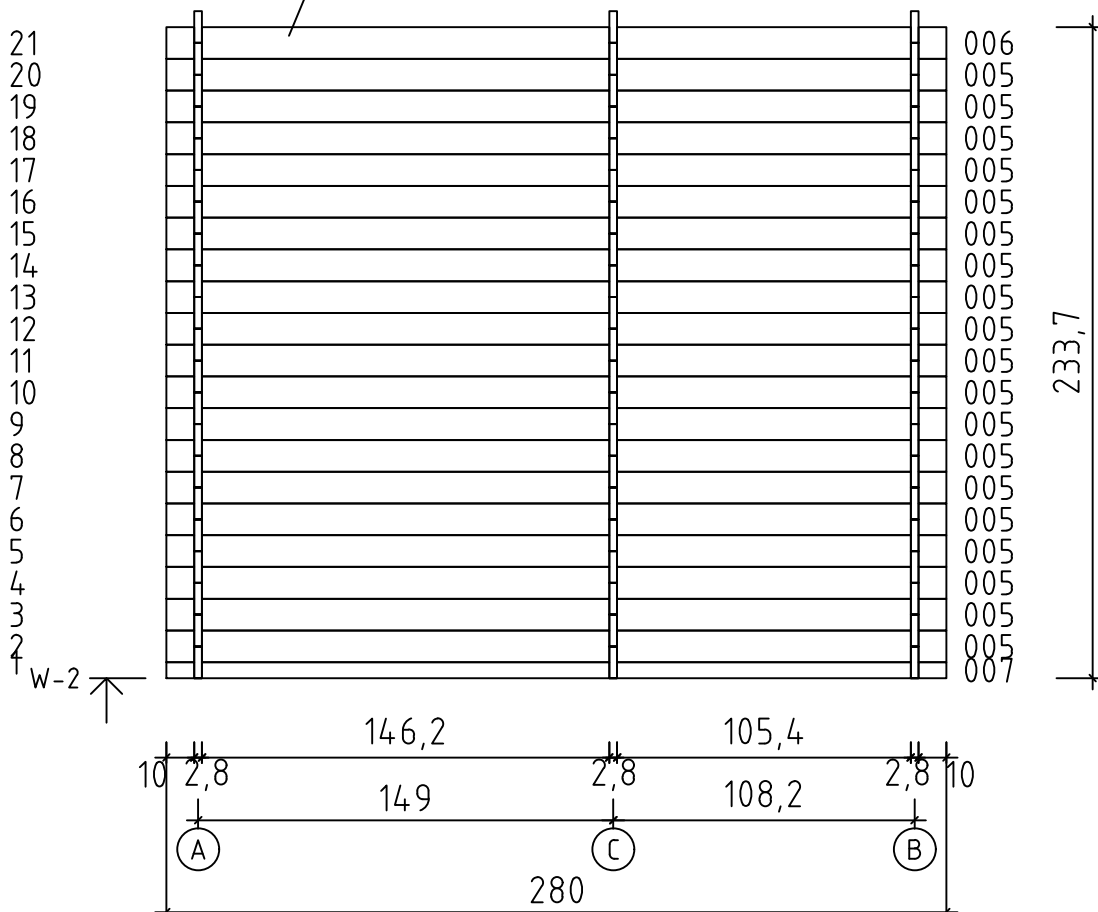



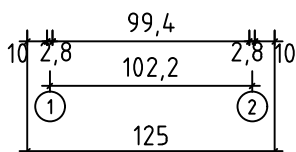
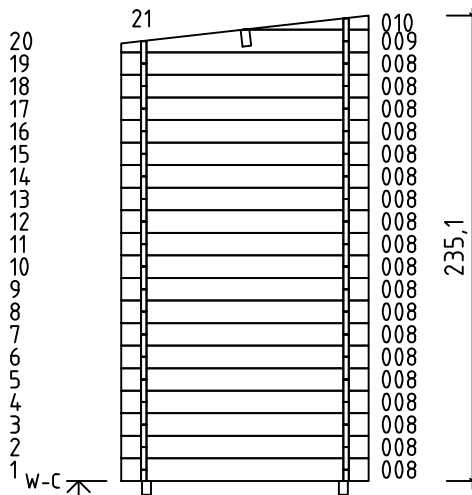
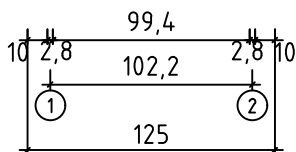
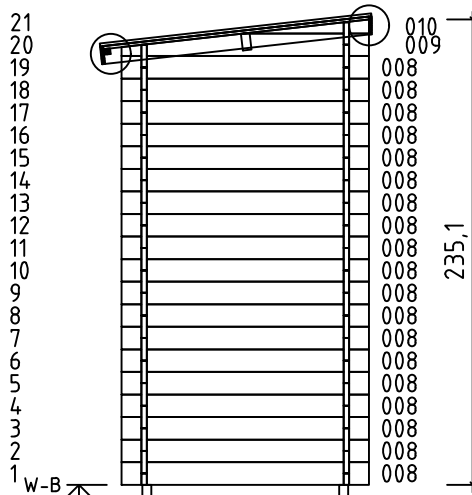
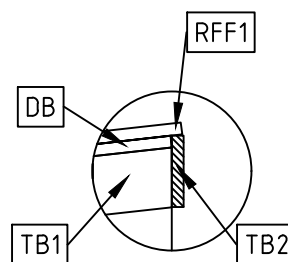
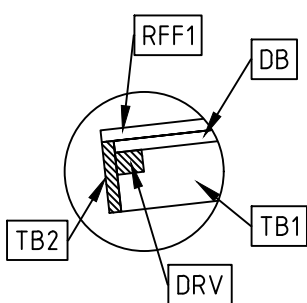
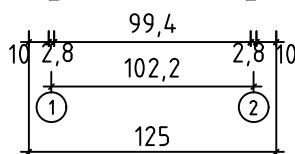
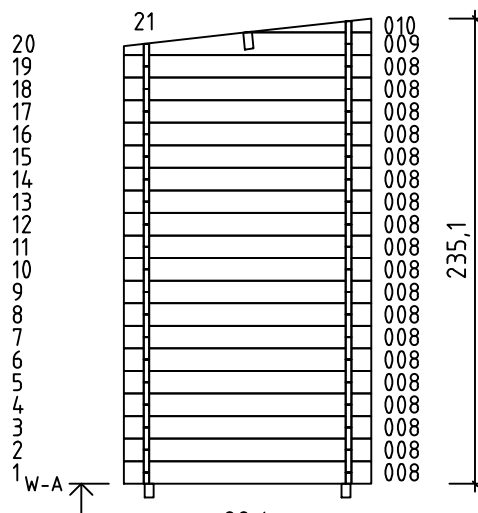





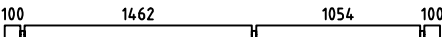
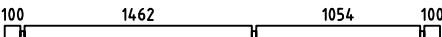

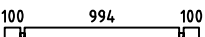
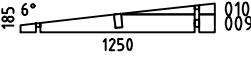
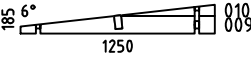
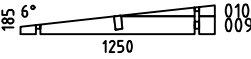
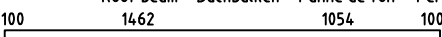



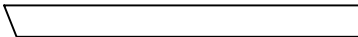
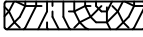

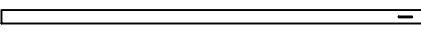
Without tongue - Ohne feder - Madrier de finition -
 Finale in leqño - Zonder veer - Punnita

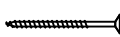

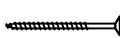

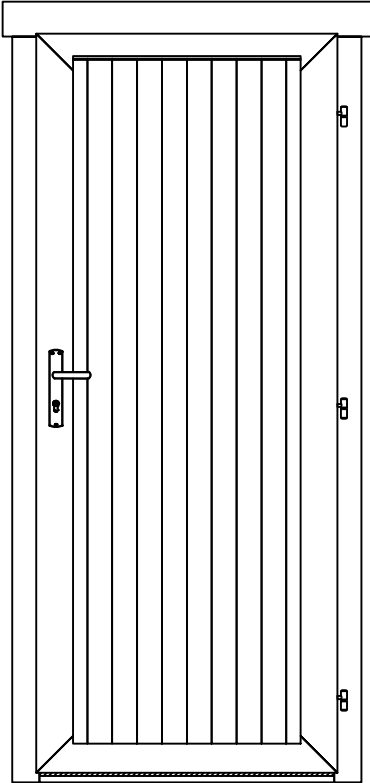
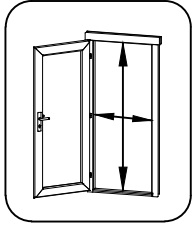

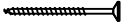
Art. Nr. 2854494

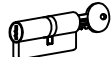
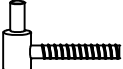

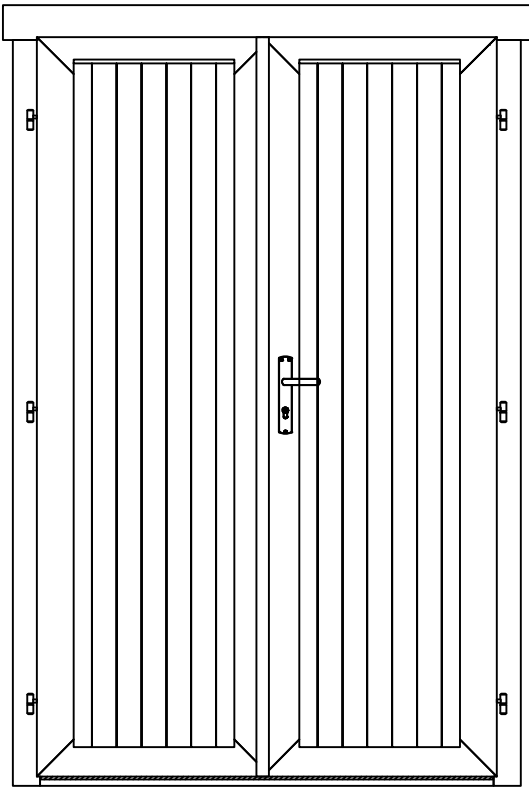
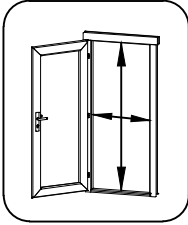
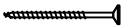
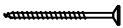
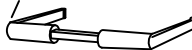
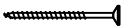
Pos	10.01.2023	Piece list - Stückliste - Liste des pièces - Elementi - Stuklijst - Tükitalabel Art. Nr. 2854494	5/6	Q	P (mm)	L (mm)
001 44655				2	28x57	238
002 35151				1	28x57	228
003 44646				34	28x114	238
004 3751				17	28x114	228
005 44647				20	28x114	2800
006 44649				2	28x114	2800
007 44650				1	28x57	2800
008 44651				57	28x114	1250
WA-1 44652				1		
WB-1 44652				1		
WC-1 44652				1		
A-PR1 44653		Roof beam - Dachbalken - Panne de toit - Perlina del tetto - Gordingen / dakbalk - Pärilin 		1	44x95	2800
DB 938	Roof boards - Dachbretter - Voliges - Perlina per tetto - Dakhout - Katuselaud			32	90x15	1350
RFF1 22781	Roofing felt fillet - Dachpappenleiste - Baguette de fixation du feutre bitumeux - Asse per fissaggio guaina bituminosa - Afdeklijst asfaltpapier - Katusepapiliist			2	15x45	1380
RFF2 22828	Roofing felt fillet - Dachpappenleiste - Baguette de fixation du feutre bitumeux - Asse per fissaggio guaina bituminosa - Afdeklijst asfaltpapier - Katusepapiliist			1	15x45	2740
TB1 44654	Fascia board - Traufbrett - Bandeau de toit - Finitura lati tetto - Gevellijst - Räästalaud			2	15x90	1350
TB2 44655	Fascia board - Traufbrett - Bandeau de toit - Finitura lati tetto - Gevellijst - Räästalaud			2	15x90	2830
DRV 702	Roof edge reinforcement - Dachrandverstärkung - Corniere de renfort de bord de toit - Rinforzo x tetto - Dakrand versterking - Räästatugevdus			1	28x34	2800
KFS-1 27180	Storm protection - Sturmleiste - Latte anti-tempete - Protezione anti vento - Stormverankering / beveliging - Tormikinnitusliist			6	22x45	2500
HS12 5109	Screw for fascia boards - Schrauben für traufbretter - Vis pour fixation bandeau de toit - Viti x striscia del tetto - Schroef voor gevellijst - Kruvi räästalauale			28	4x40	
HS12 5109	Screw for roof edge reinforcement - Schrauben für dachrandverstärkung - Vis pour fixation corniere renfort de bord de toit - Viti x rinforzo bordo tetto - Schroef voor dakrand versterking - Kruvi räästatugevdusele			7	4x40	
HS18 5113	Screw for roof beams - Schrauben für dachbalken - Vis pour fixation pannes de toit - Viti per perline del tetto - Schroef voor gordingen / dakbalken - Kruvi pärlinitele			3	5x120	
HS18 5113	Screw for gable - Schrauben für giebel - Vis pour fixation des pignons - Viti per timpano - Schroef voor gevelpunt - Kruvi viilude kinnitamiseks			6	5x120	

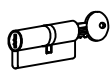
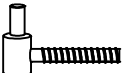
Pos	09.01.2023	Piece list - Stückliste - Liste des pièces - Elementi - Stuklijst - Tükitalabel 835x1957 UL.2.100.IVP.MMW TC+O	1/1	Q	P (mm)	L (mm)
		  <p>735x1907 mm</p>				
HS16	Screw for door jamb - Schraube für Türrahmen - Vis de fixation partie haute avec montants du cadre de porte - Viti x fissaggio montanti porte - Schroef voor deurkozijn - Kruvi ukse lengile		4	5x90		
HS25	Screw for doorstep - Schrauben für swelle - Vis pour fixation barre de seuil - Vite per soglia della porta - Schroef voor deurdorpel - Kruvi lävepakule		2	4.5x65		
TL4	Door handle fittings - Türgriff - Poignée de porte - Maniglie - Deurhendel / klink - Ukse käepide		1			
TL5	Set of door lock covers - Schlossblenden - Set de garnitures de porte - Copertura serrature - Slot sluitplaat set - Ukse lukuplaat		1			
	Cylinder lock - Zylinderschloss - Barillet de porte - Serratura - Cylinder slot - Ukse lukusüdamik		1	30x35		
	Male bolt hinge for door - Türband - Partie male de paumelle de porte - Cerniera anube x porta - Scharnier bout - Ukse polthing isane		3			

Pos	09.01.2023 Piece list - Stückliste - Liste des pièces - Elementi - Stuklijst - Tükítabel 1244x1957 TUL.2.100.IVP.MMWe TC+0	1/1	Q	P (mm)	L (mm)
					
					
					1144x1907 mm
HS4	Screw for door fillet - Schraube zur Befestigung türleiste - Vis pour fixation baguette d'arrêt de porte - Viti per massellino della porta - Schroef voor deurlijst - Kruvi ukse kokkuvältsiliistule		5	3x30	
HS16	Screw for door jamb - Schraube für Türrahmen - Vis de fixation partie haute avec montants du cadre de porte - Viti x fissaggio montanti porte - Schroef voor deurkozijn - Kruvi ukse lengile		6	5x90	
TL4	Door handle fittings - Türgriff - Poignée de porte - Maniglie - Deurhendel / klink - Ukse käepide VU		1		
HS25	Screw for doorstep - Schrauben für swelle - Vis pour fixation barre de seuil - Vite per soglia della porta - Schroef voor deurdorpel - Kruvi lävepakule		3	4.5x65	
TL5	Set of door lock covers - Schlossblenden - Set de garnitures de porte - Copertura serrature - Slot sluitplaat set - Ukse lukuplaat		1		
	Cylinder lock - Zylinderschloss - Barillet de porte - Serratura - Cylinder slot - Ukse lukusüdamik		1		
	Male bolt hinge for door - Türband - Partie male de paumelle de porte - Cerniera anube x porta - Scharnier bout - Ukse polthing isane		6		
	Striker for barrel bolt - Hülse für Grendelriegel - Gache au sol du targette - Boccola per fermo della porta - Huls voor vergrendelingsschuif - Vasturaud ukse servariivile		2		