

Art. Nr. 2840096

1/6

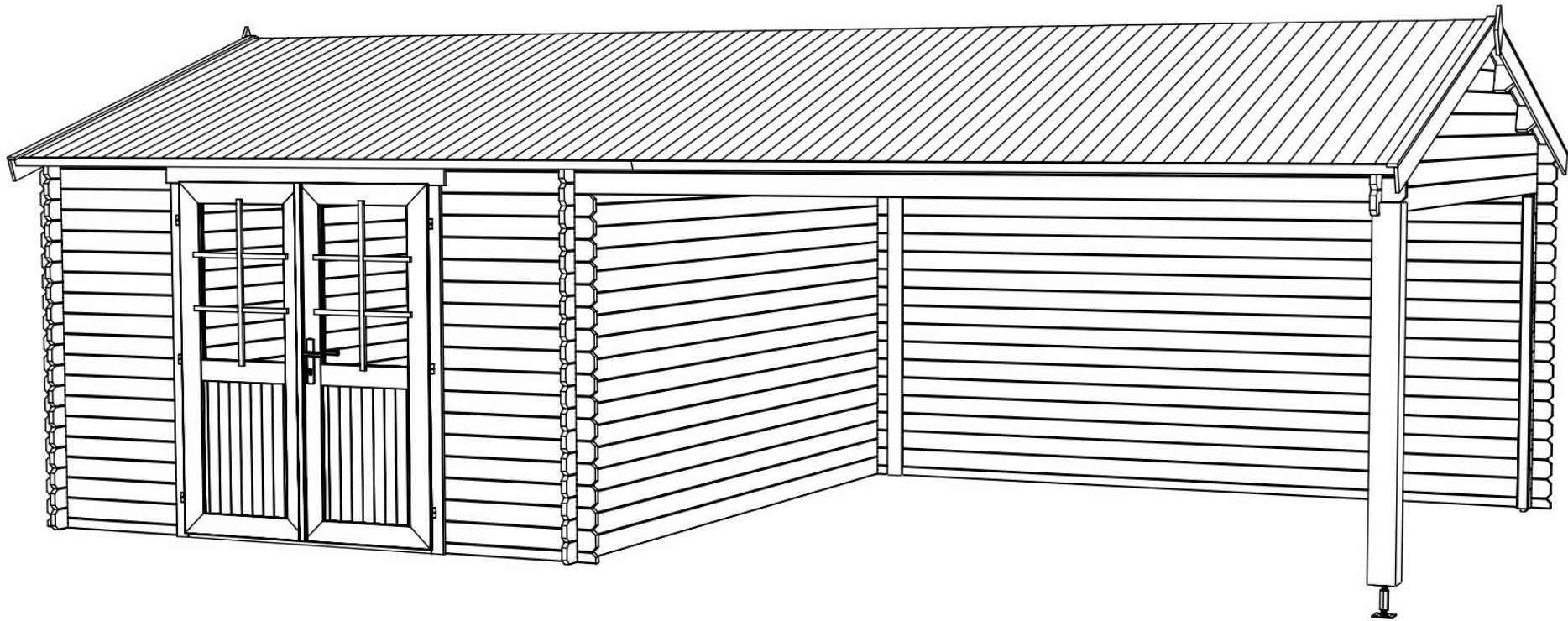

29/10/2023

Art. Nr. 2840096

Groundplan - Grundplan - Plan de masse - Planimetria -
Plattegrond - Põhiplaan

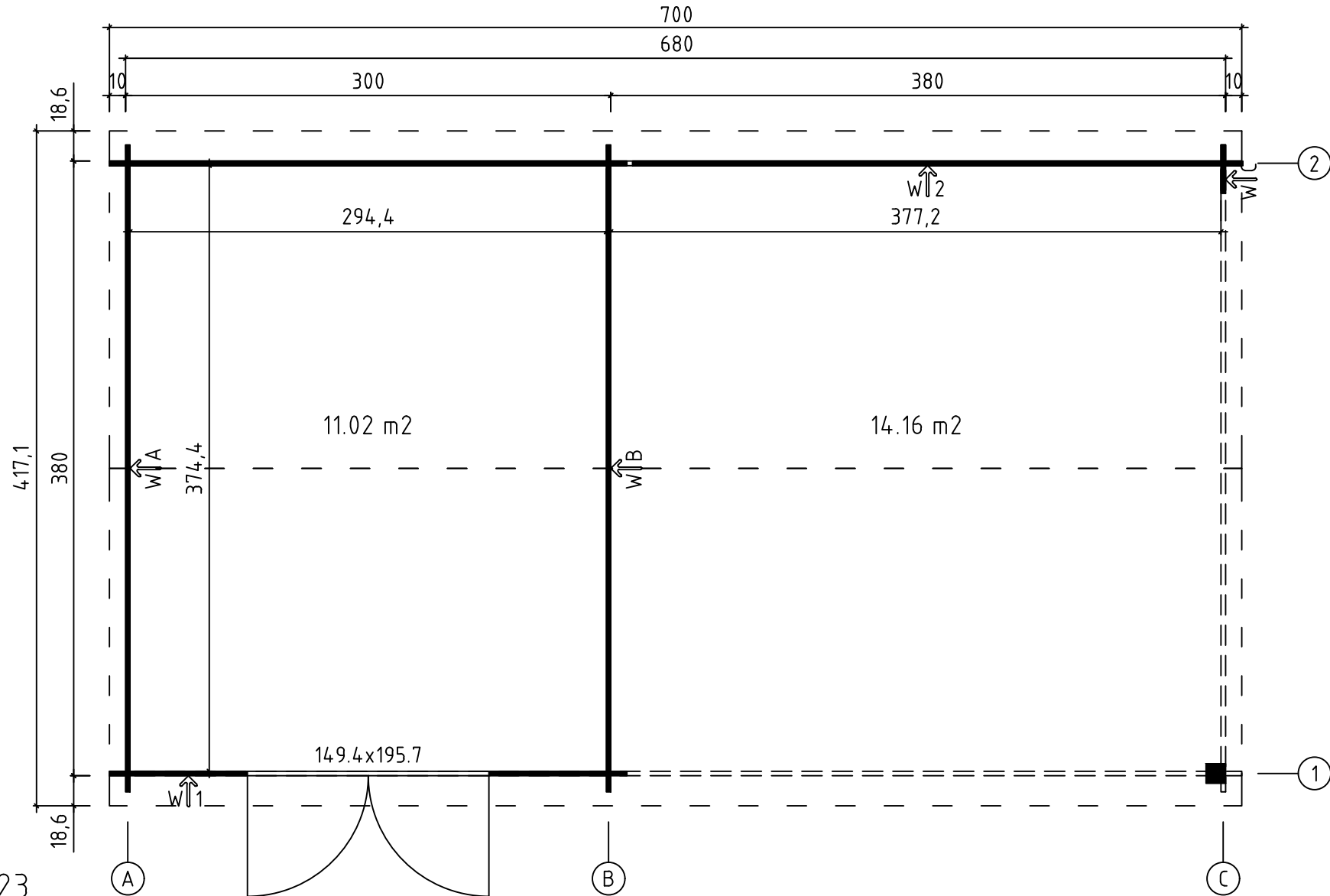

29.10.2023

2/6

Art. Nr. 2840096



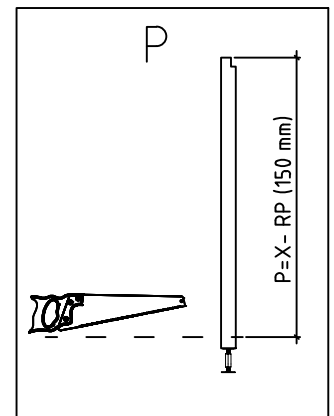
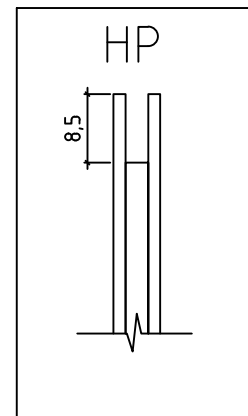
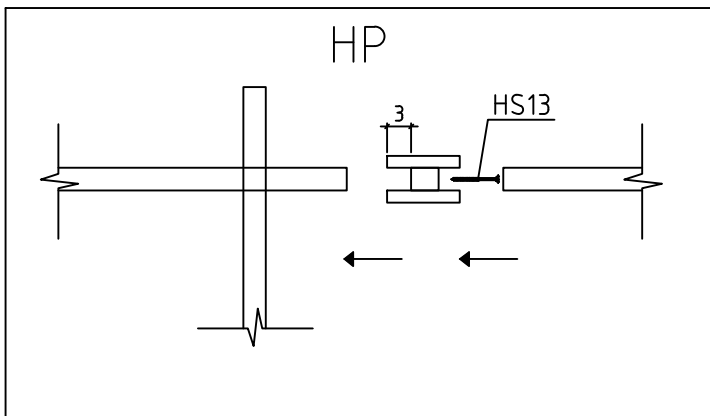
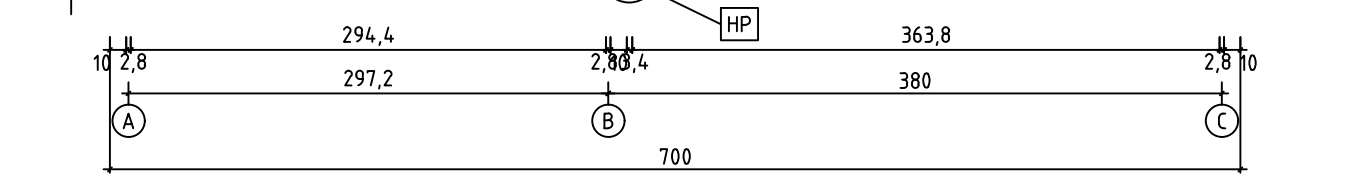
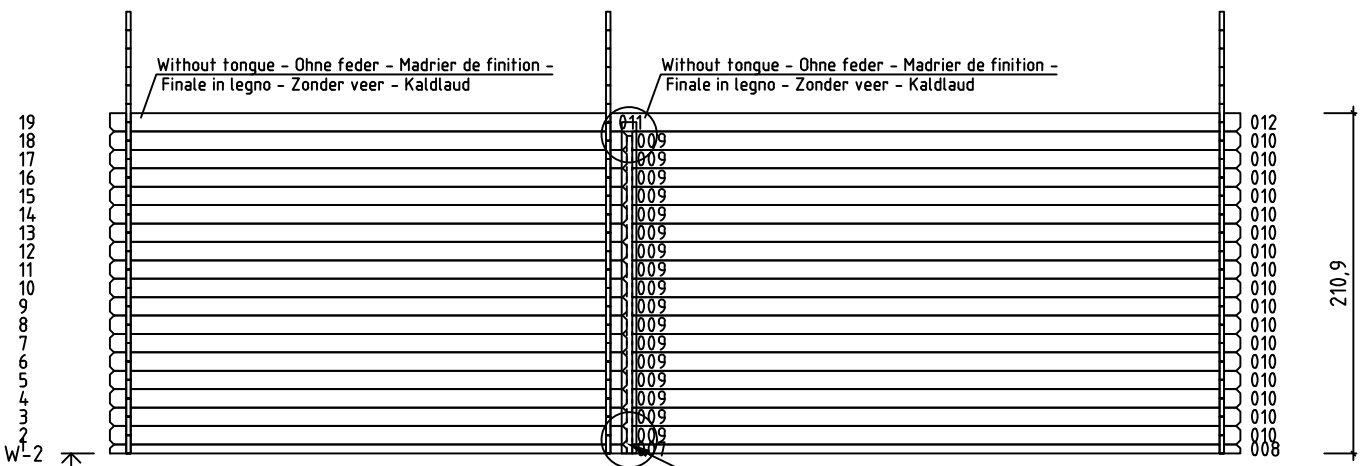
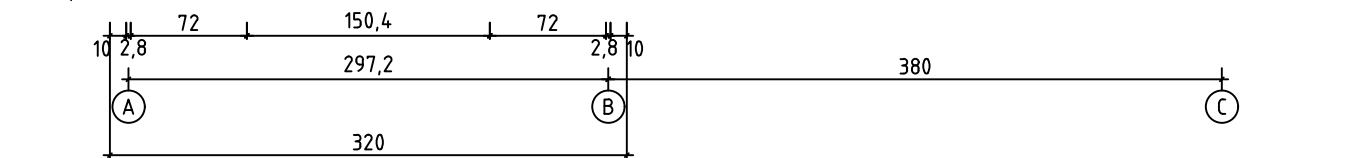
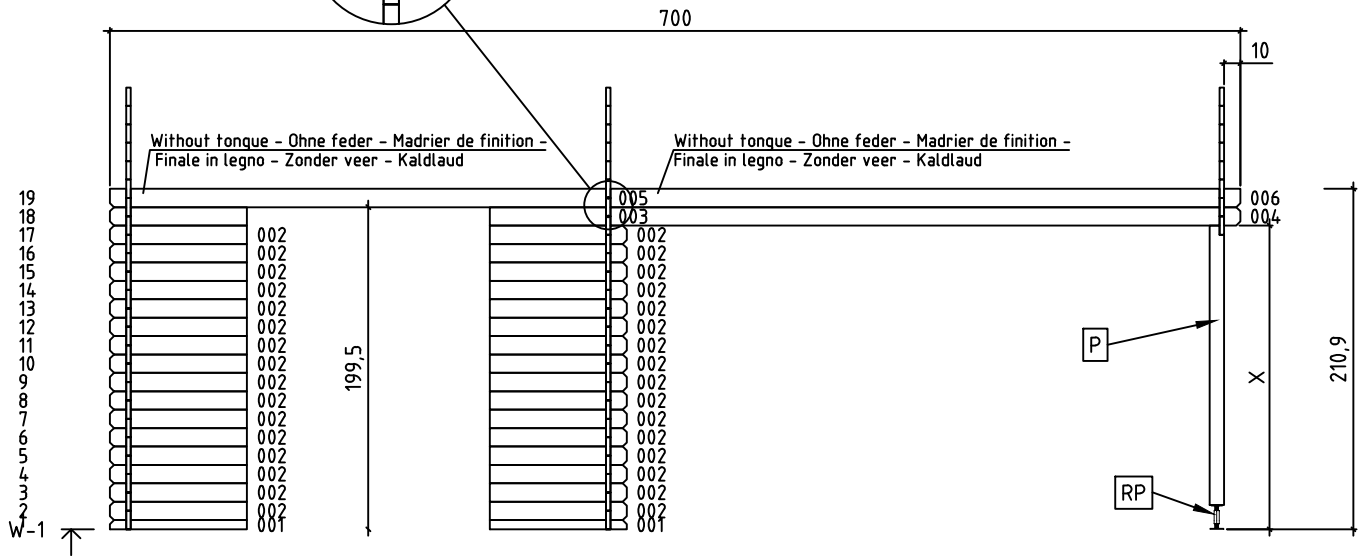
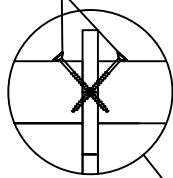

HS18

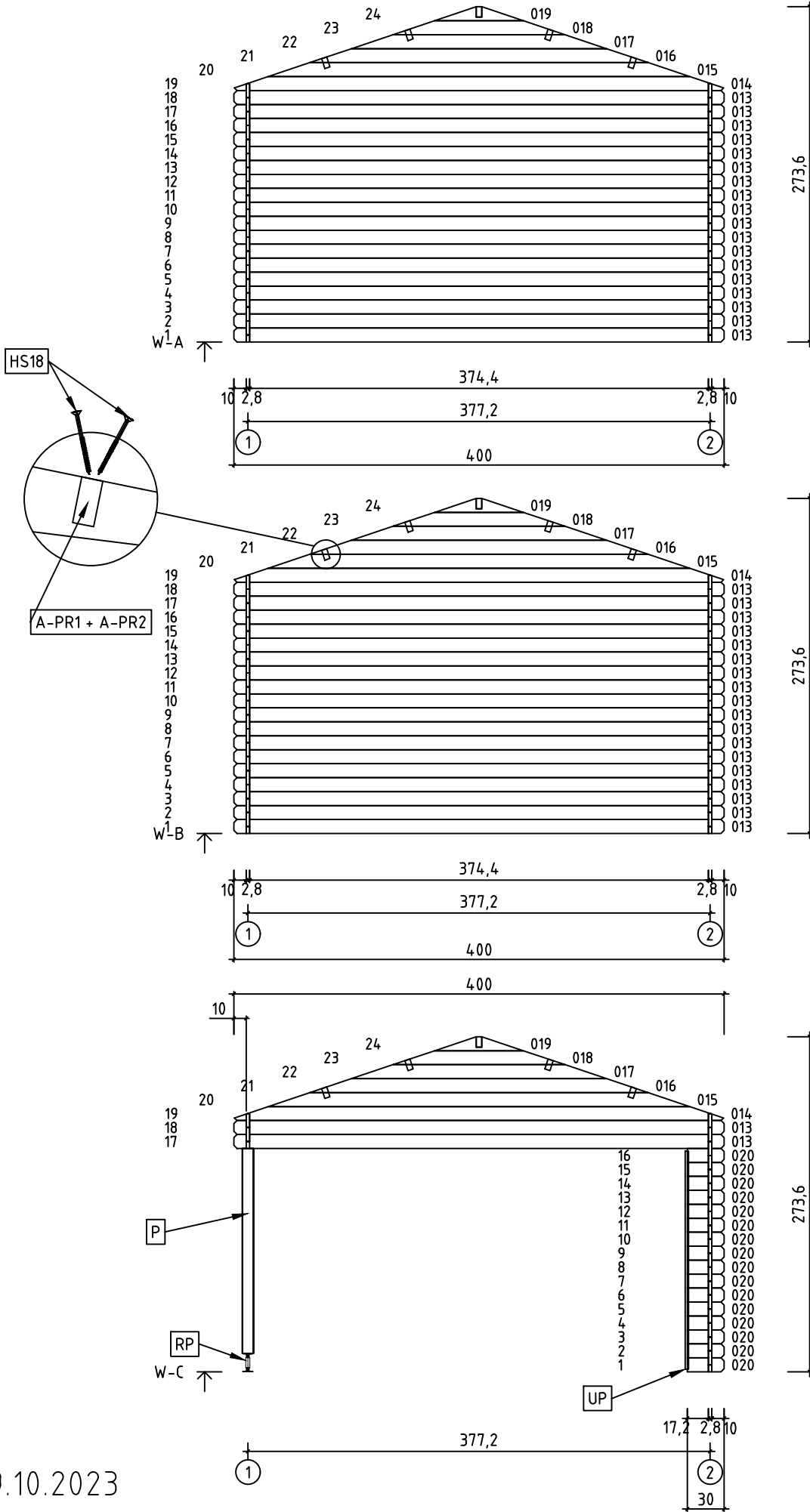



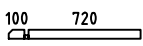
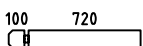
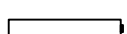
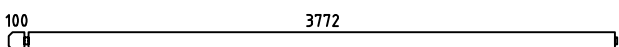
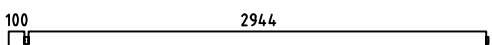
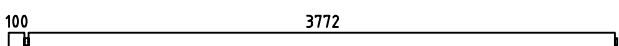
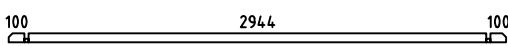
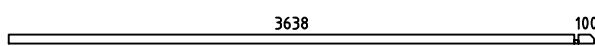
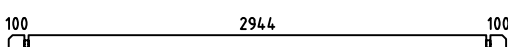
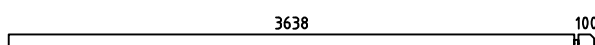
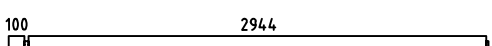
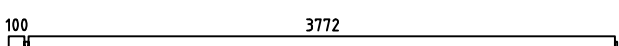
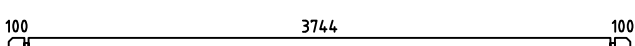

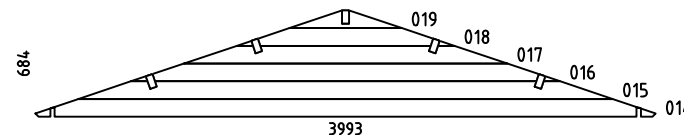
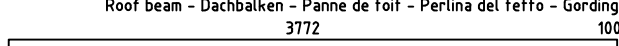
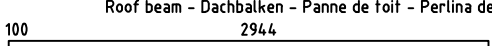
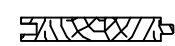
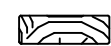
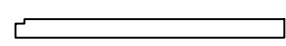



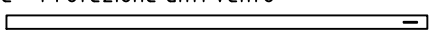

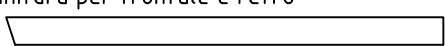

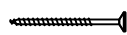

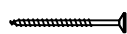
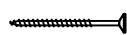

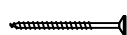
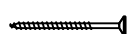



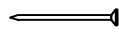
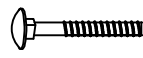

Art. Nr. 2840096

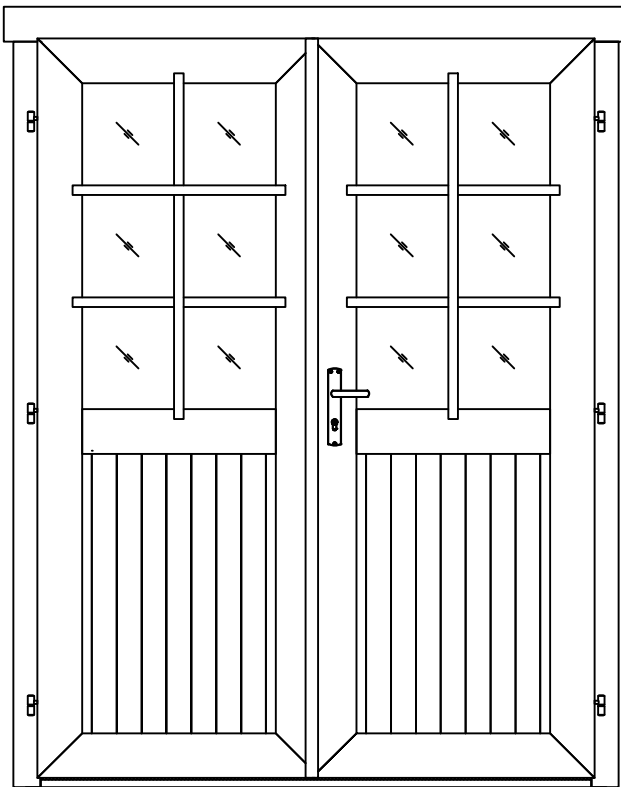
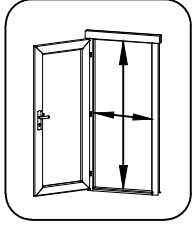
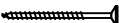
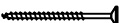
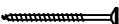

29.10.2023

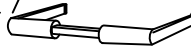
| Pos | 29.10.2023 Piece list - Stückliste - Liste des pièces - Elementi - Stuklijst - Tükítabel Art. Nr. 2840096 5/6 | Q | P (mm) | L (mm) |
|----------------------|--|-------------|-----------|-----------|
| 001 |  | 2 | 28x57 | 848 |
| 002 |  | 33 | 28x114 | 848 |
| 003 |  | 1 | 28x114 | 734 |
| 004 |  | 1 | 28x114 | 3914 |
| 005 |  | 1 | 28x114 | 3086 |
| 006 |  | 1 | 28x114 | 3914 |
| 007 |  | 1 | 28x57 | 3200 |
| 008 |  | 1 | 28x57 | 3766 |
| 009 |  | 17 | 28x114 | 3200 |
| 010 |  | 17 | 28x114 | 3766 |
| 011 |  | 1 | 28x120 | 3086 |
| 012 |  | 1 | 28x120 | 3914 |
| 013 |  | 38 | 28x114 | 4000 |
| 020 |  | 16 | 28x114 | 300 |
| WA-1 WB-1 WC-1 |  | 1 1 1 | | |
| A-PR2 | Roof beam - Dachbalken - Panne de toit - Perlina del tetto - Gordingen / dakbalk - Pärlin  | 5 | 44x146 | 3914 |
| A-PR1 | Roof beam - Dachbalken - Panne de toit - Perlina del tetto - Gordingen / dakbalk - Pärlin  | 5 | 44x146 | 3086 |
| | Roof boards - Dachbretter - Voliges - Perlina per tetto - Dakhout - Katuselaud  | 156 | 90x15.5 | 2200 |
| | Roofing felt fillet - Dachpappenleiste - Baguette de fixation du feutre bitumeux - Asse per fissaggio guaina bituminosa - Afdekljst asfaltpapier - Katusepapiilist  | 4 | 15x45 | 2250 |
| P | Post - Pfosten - Poteau - Piede registrabile - Stijl - Post  | 1 | 120x120 | 1780 |
| TB-1 | Fascia board - Traufbrett - Bandeau de toit - Finitura lati tetto - Gevellijst - Räästalaud  | 4 | 15x45 | 3500 |
| HP | H-profile - H-profiils - Profile H - Profilo ad H - H-profiel - H-profiil  | 1 | 58x90 | 2050 |

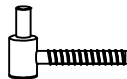
| Pos | Piece list - Stückliste - Liste des pièces - Elementi - Stuklijst - Tükítabel 29.10.2023 Art. Nr. 2840096 6/6 | Q | P (mm) | L (mm) |
|-------|---|-----|-----------|-----------|
| KFS-1 | Storm protection - Sturmleiste - Latte anti-tempete - Protezione anti vento - Stormverankering / beveiliging - Tormikinnitusliist  | 5 | 22x45 | 2500 |
| UP | U-profile - U-profiils - Profile u - Profilo ad u - U-profiel - U-profiil  | 1 | 28x58 | 1780 |
| | Gable moulding - Giebelleiste - Planche de rive - Finitura per frontale e retro del tetto - Gevellijst - Viilulaud  | 4 | 15x120 | 2250 |
| HS8 | Screw for gable segment - Schrauben für deckblatt - Vis pour fixation losange de finition - Viti x frontali tetto - Schroef voor gevelpunt segment - Kruvi  | 4 | 3.5x35 | |
| HS9 | Screw for u-profile - Schraube zur befestigung u-profiils - Vis a tete fraisée pour profil u - Vite per profilo ad u - Schroef ter bevestiging u-profiel - Kruvi U-profiilile  | 4 | 3.5x50 | |
| HS9 | Screw for gable moulding - Schrauben für giebelleiste - Vis pour fixation planche de rive - Vite per fissare finiture davanti e dietro del tetto - Schroef voor gevellijst - Kruvi viilulauale  | 32 | 3.5x50 | |
| HS4 | Screw for fascia boards - Schrauben für traufbretter - Vis pour fixation bandeau de toit - Viti x striscia del tetto - Schroef voor gevellijst - Kruvi räästalauale  | 32 | 3x30 | |
| HS13 | Screw for h-profile - Schraube zur befestigung h-profiils - Vis a tete fraisée pour profil h - Vite per profilo ad h - Schroef ter bevestiging h-profiel - Kruvi H-profiilile  | 1 | 4x60 | |
| HS18 | Screw for roof beams - Schrauben für dachbalken - Vis pour fixation pannes de toit - Viti per perline del tetto - Schroef voor gordingen / dakbalken - Kruvi pärlinitele  | 20 | 5x120 | |
| HS18 | Screw for wall details - Schraube für wand details - Vis pour mur details - Viti per elementi della porta - Schroef voor wand details - Kruvi seinadetailile  | 6 | 5x120 | |
| HS18 | Screw for gable - Schrauben für giebel - Vis pour fixation des pignons - Viti per timpano - Schroef voor gevelpunt - Kruvi viilude kinnitamiseks  | 6 | 5x120 | |
| HS16 | Screw for post - Schrauben für pfosten - Vis de fixation des poteaux - Viti per inviare - Schroef voor stijlen - Kruvi postile  | 2 | 5x90 | |
| HS20 | Screw for post height adjustment - Schrauben für regulierungsschraube für pfosten - Vis de fixation de support réglable de poteau - Viti per fissare ed aggiustare l'altezza del palo verticale - Schroef voor hoogte instelling stijlen - Kruvi vajumisplidile  | 8 | 6x50 | |
| SH28 | Hammer block - Schlagholz - Calle de frappe - Blocco di legno da usare come cuscinetto quando si usa il martello - Slagklos - Löögiklots  | 1 | | |
| SFS | Nut for storm protection - Schraubenmutter für sturmleiste - Ecrou pour latte anti-tempete - Dado x asta protezione vento - Moer voor stormverankering - Mutter tormikinnitusliistule  | 10 | D6 | |
| NF4 | Zn nail for roof - Zn nägel für dachbretter - Pointe pour fixation voliges de toit - Chiodi x perline tetto - Spijker(nagel) voor dakhout - Nael katuselauale  | 644 | 2x50 | |
| NF5 | Zn nail for roofing felt fillet - Zn nägel für dachpappenleiste - Pointe pour baguette de fixation feutre bitumeux - Chiodi x carta bituminosa x tetto - Spijker(nagel) voor asfaltpapier afdeklijst - Papiliistunael  | 20 | 2x40 | |
| BFS | Bolt for storm protection - Bolzen für sturmleiste - Boulon pour latte anti-tempete - Bullone x asta protezione vento - Bout voor stormankerlat - Puidupolt tormikinnitusliistule  | 10 | 6x60 | |
| GS | Gable segment - Deckblatt - Losange de finition - Decorazione in legno x frontale tetto - Gevelpunt segment - Romb  | 2 | | |
| DFS | Washer for storm protection - Dichtscheibe für sturmleiste - Rondelle pour latte anti-tempete - Rondella x asta protezione vento - Afdichting voor storm strip - Seib tormikinnitusliistule  | 10 | D6 | |
| RP | Post height adjustment - Pfostenträger verstellbar - Support réglable de poteau - Piede registrabile in altezza - Stelschroef voor stijlpot - Vajumisplott  | 1 | D20 | |
| | Door - Tür - Porte - Porte - Deur - Uks 1494x1957 TUK.2.056.SVP.MMb SGC | 1 | | |

| Pos | 13.01.2017 | Piece list - Stückliste - Liste des pièces - Elementi - Stuklijst - Tükítabel 14.94x1957 TUK.2.056.SVP.MMb SGC | 1/1 | Q | P (mm) | L (mm) |
|------|--|---|-----|--------|-----------|-----------|
| | | Glass size - Glasgröße - Taille de la vitre - Misura del vetro - Glas afmeting - Klaasi mõõt: 514x855 mm | | | | |
| | |  | | | | |
| | |  1394x1875 mm | | | | |
| HS1 | Screw for georgian bars - Schraube für sprossen - Vis pour croisillons - Viti per unire la griglia georgiana della finestra - Schroeven voor raamverdeling - Krugi ukse peffeliistule |  | 12 | 2.5x20 | | |
| HS4 | Screw for door fillet - Schraube zur befestigung türleiste - Vis pour fixation baguette d'arret de porte - Viti per massellino della porta - Schroef voor deurlijst - Krugi ukse kokkuvaltsiliistule |  | 5 | 3x30 | | |
| HS16 | Screw for door jamb - Schraube für türrahmen - Vis de fixation partie haute avec montants du cadre de porte - Viti x fissaggio montanti porte - Schroef voor deurkozijn - Krugi ukse lengile |  | 4 | 5x90 | | |
| HS25 | Screw for doorstep - Schrauben für swelle - Vis pour fixation barre de seuil - Vite per soglia della porta - Schroef voor deurdorpel - Krugi lävepakule |  | 3 | 4.5x65 | | |
| TL4 | Door handle fittings - Türgriff - Poignee de porte - Maniglie - Deurhendel / klink - Ukse käepide |  | 1 | | | |
| TL5 | Set of door lock covers - Schlossblenden - Set de garnitures de porte - Copertura serrature - Slot sluitplaat set - Ukse lukuplaat |  | 1 | | | |
| | Cylinder lock - Zylinderschloss - Barillet de porte - Serratura - Cylinder slot - Ukse lukusüdamik |  | 1 | 30x35 | | |
| | Male bolt hinge for door - Türband - Partie male de paumelle de porte - Cerniera anube x porta - Scharnier bout - Ukse polthing isane |  | 6 | | | |
| | Striker for barrel bolt - Hülse für grendelriegel - Gache au sol du targette - Boccola per fermo della porta - Huls voor vergrendelingsschuif - Vasturaud ukse servariivile |  | 2 | | | |