

Art. Nr. 2816101

1/8



15.05.2018

Groundplan - Grundplan - Plan de masse - Planimetria - Plattegrond - Põhiplan

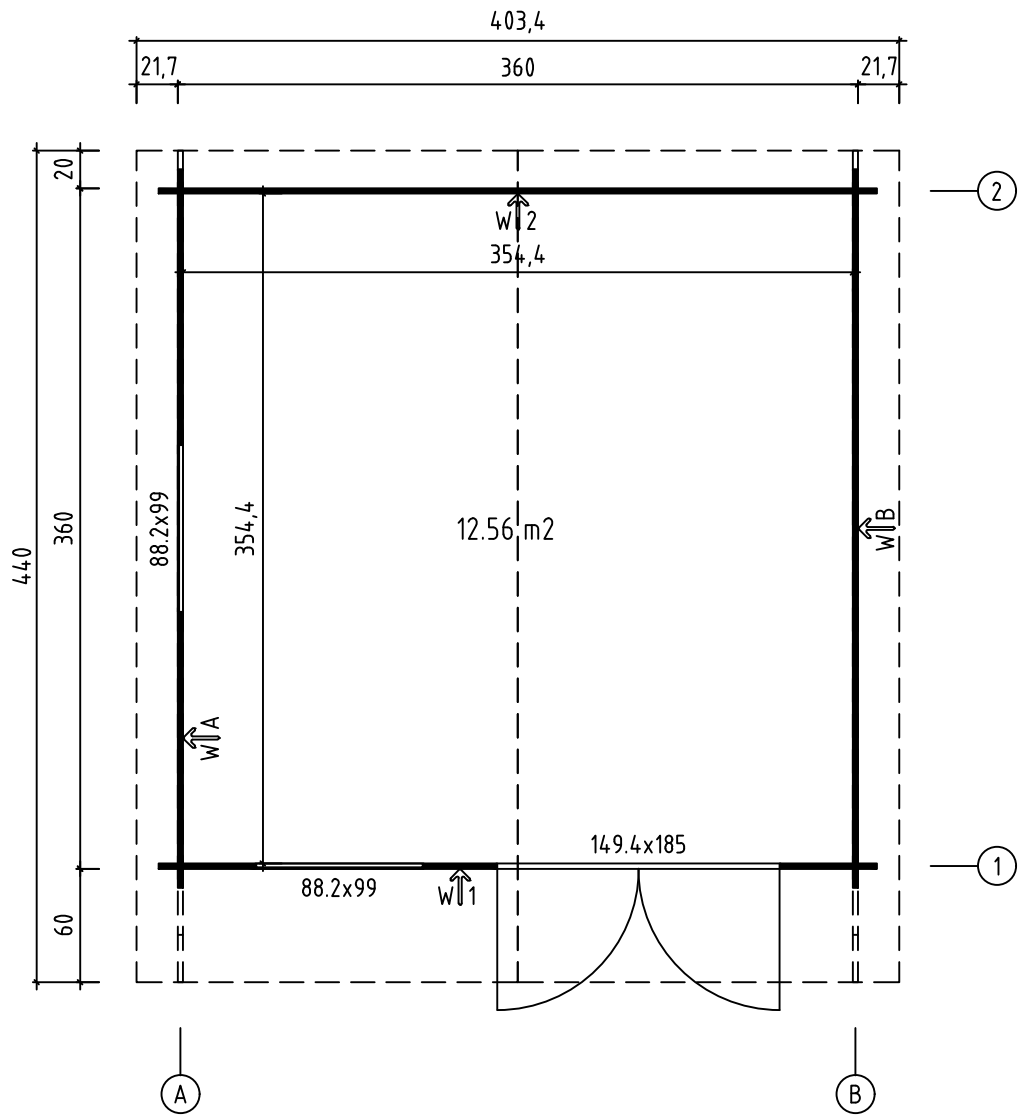





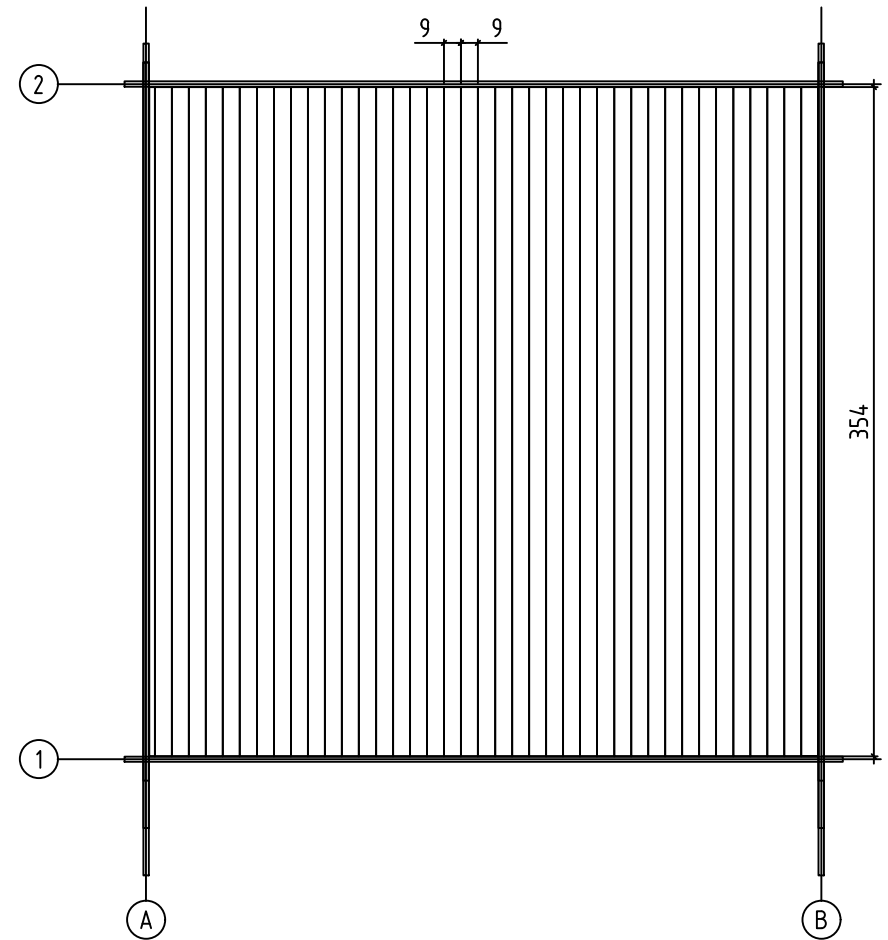
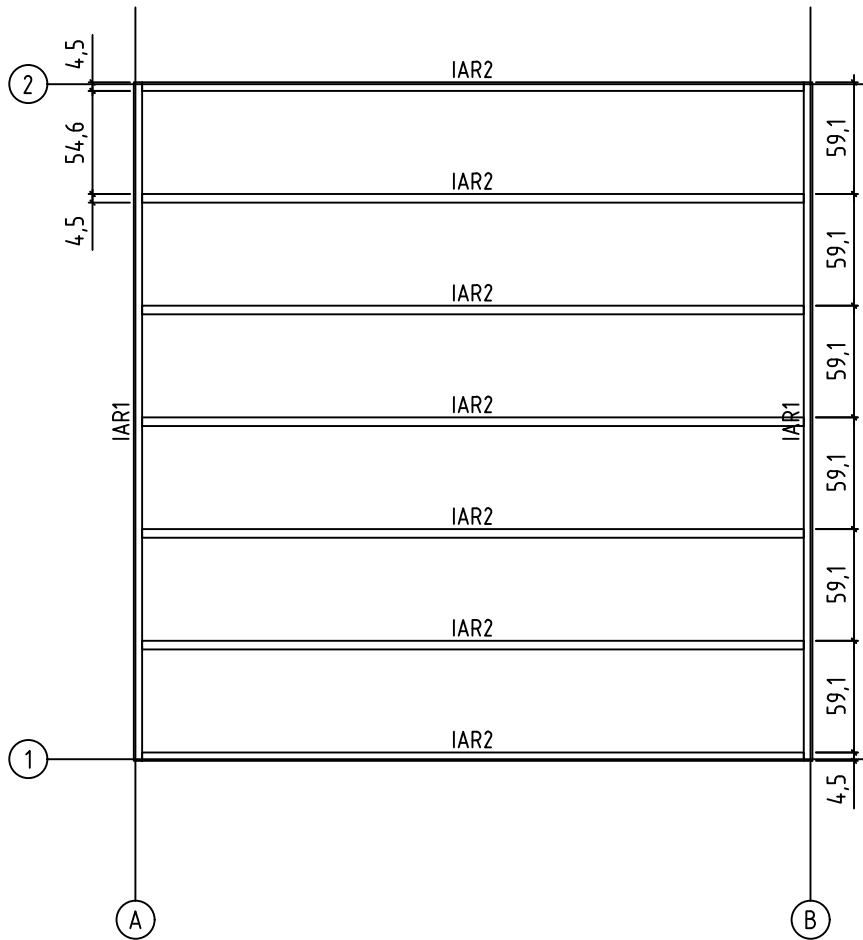

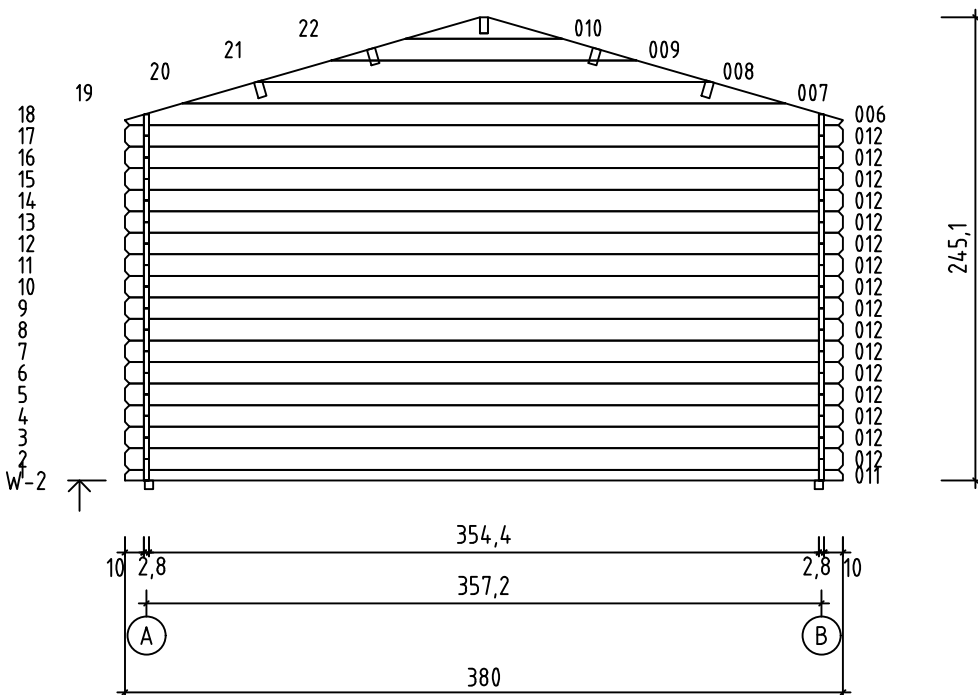
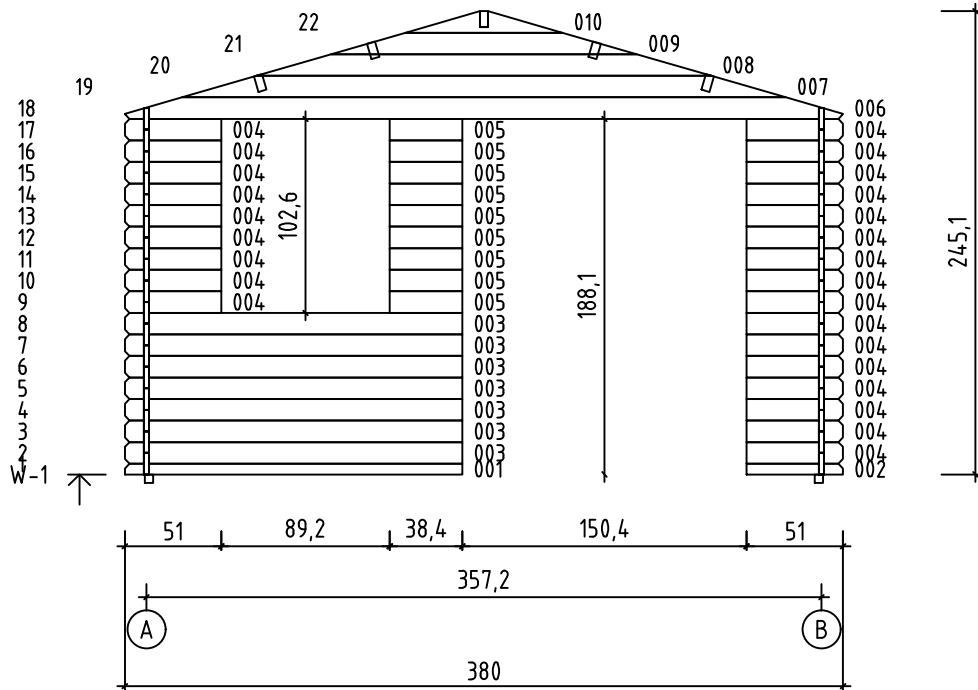

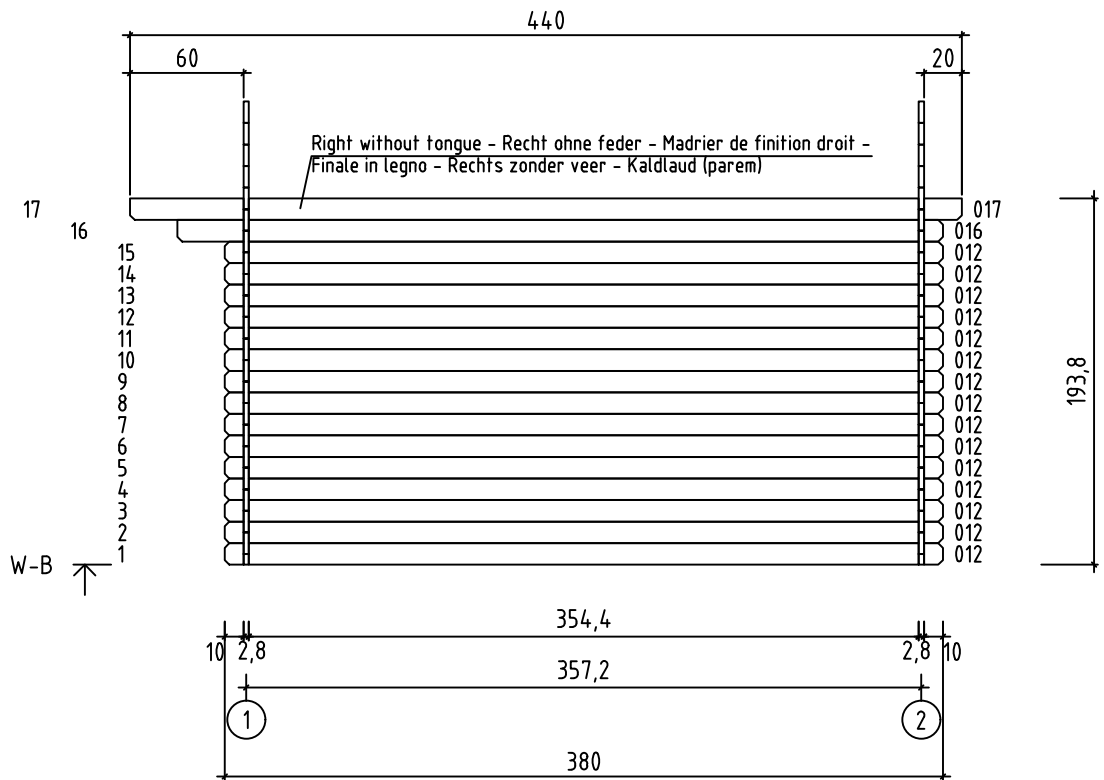
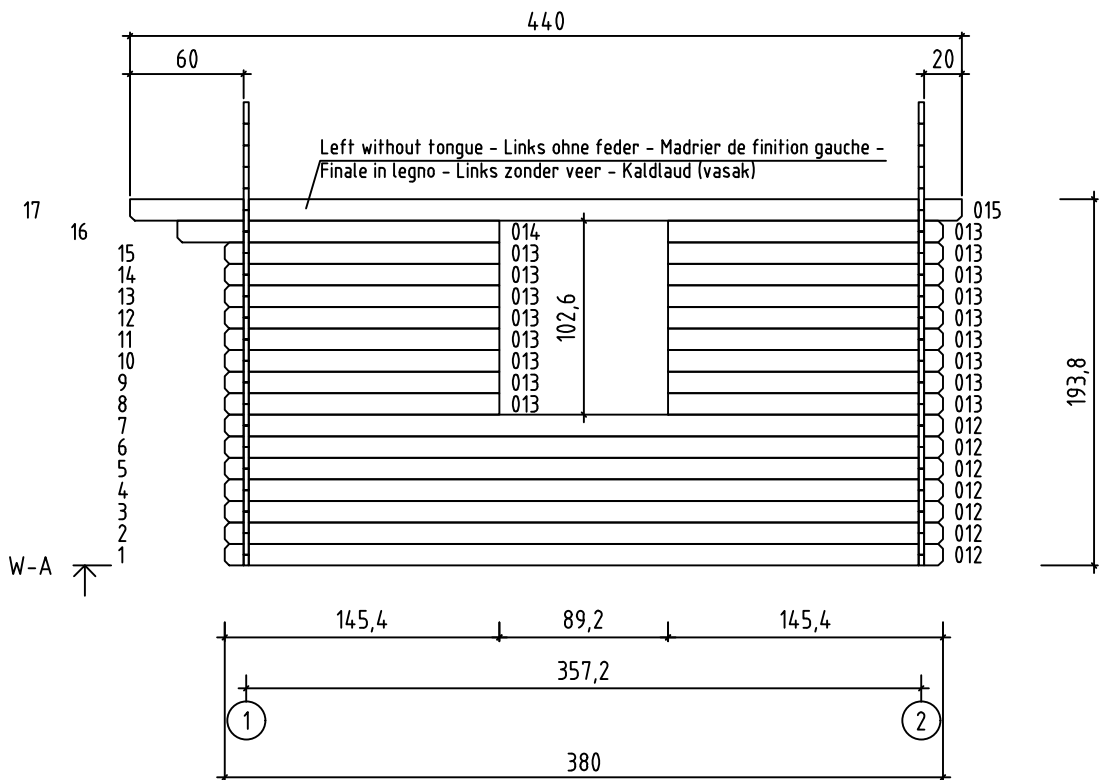

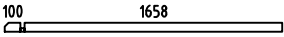
Foundation - Fundament - Fondation - Fondamenta - Fundering - Immutatud alusraam

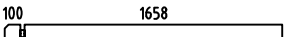

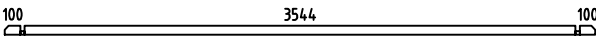
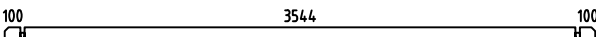
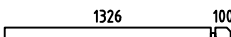
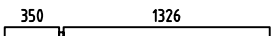
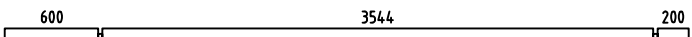
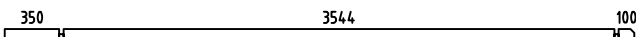
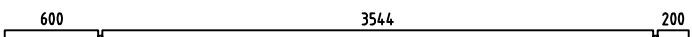
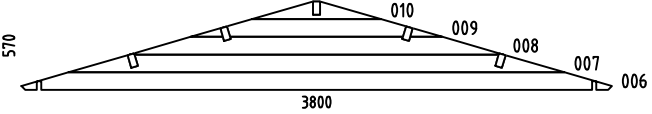
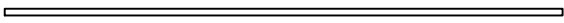
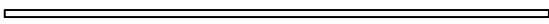

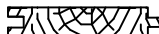

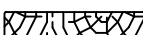

Floor boards - Fussbodenbretter - Plan pose placher - Pavimento - Vloerhout - Põrandalaudis

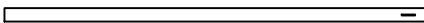
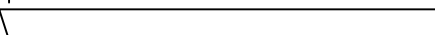
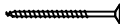
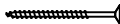
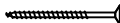
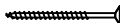
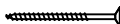
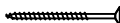
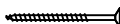



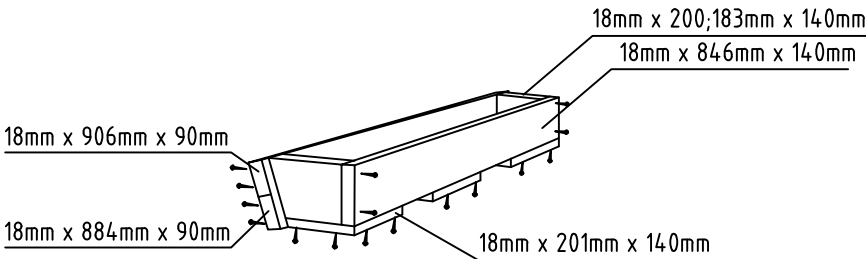



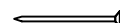

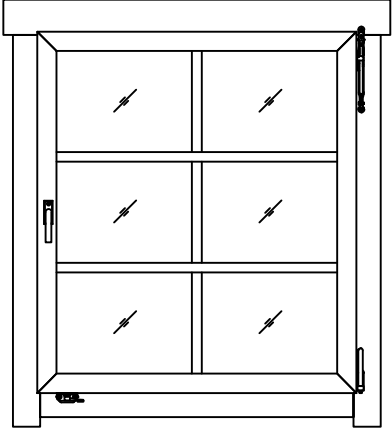
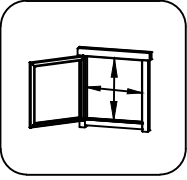
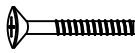
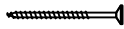

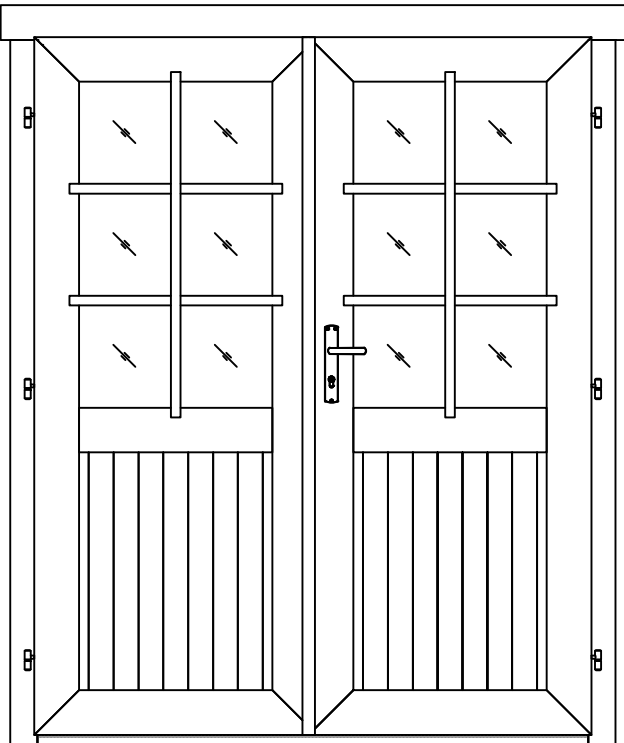
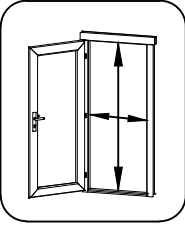
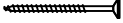
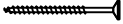
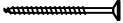
| Pos | 15.05.2018 Piece list - Stückliste - Liste des pièces - Elementi - Stuklijst - Tükitalabel Art. Nr. 2816101 | 6/8 | Q | P (mm) | L (mm) |
|--------------|--|-----|--------|-----------|-----------|
| 001 |  | | 1 | 28x57 | 1786 |
| 002 |  | | 1 | 28x57 | 510 |
| 003 |  | | 7 | 28x114 | 1786 |
| 004 |  | | 25 | 28x114 | 510 |
| 005 |  | | 9 | 28x114 | 384 |
| 011 |  | | 1 | 28x57 | 3800 |
| 012 |  | | 38 | 28x114 | 3800 |
| 013 |  | | 17 | 28x114 | 1454 |
| 014 |  | | 1 | 28x114 | 1704 |
| 015 |  | | 1 | 28x120 | 4400 |
| 016 |  | | 1 | 28x114 | 4050 |
| 017 |  | | 1 | 28x120 | 4400 |
| W1-1 W2-1 |  | | 1 1 | | |
| IAR1 | Foundation - Fundament - Fondation - Fondamenta - Fundering - Immutatud alusraam  | | 2 | 45x45 | 3590 |
| IAR2 | Foundation - Fundament - Fondation - Fondamenta - Fundering - Immutatud alusraam  | | 7 | 45x45 | 3500 |
| A-PR1 | Roof beam - Dachbalken - Panne de toit - Perlina del tetto - Gordingen / dakbalk - Pärilin  | | 5 | 44x140 | 4400 |
| | Floor boards - Fussbodenbretter - Lame de plancher - Pavimento - Vloerhout - Põrandalaud  | | 40 | 90x18 | 3540 |
| | Roof boards - Dachbretter - Voliges - Perlina per tetto - Dakhout - Katuselaud  | | 98 | 90x18 | 2100 |
| | Floor fillet - Fussbodenleiste - Corniere de finition du plancher - Finitura per pavimento (battisco pa) - Vloerafwerklijst - Põrandaliist  | | | 18x18 | 14.16 |
| | Roofing felt fillet - Dachpappenleiste - Baguette de fixation du feutre bitumeux - Asse per fissaggio guaina bituminosa - Afdeklijst asfaltpapier - Katusepapiilist  | | 4 | 18x58 | 2150 |
| DPP-1 | Roofing felt (strip) - Dachpappe (bahnen) - Feutre bitumeux (bande) - Cartone catramato - Asfaltpapier (baan) - Katusepapp  | | 5 | | 4500 |
| TB-1 | Fascia board - Traufbrett - Bandeau de toit - Finitura lati tetto - Gevellijst - Räästalaud  | | 2 | 18x90 | 4400 |

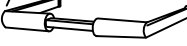
| Pos | 15.05.2018 Piece list - Stückliste - Liste des pièces - Elementi - Stuklijst - Tükítabel Art. Nr. 2816101 | 7/8 | Q | P (mm) | L (mm) |
|-------|--|-----|-----|-----------|-----------|
| DRV-1 | Roof edge reinforcement - Dachrandverstärkung - Corniere de renfort de bord de toit - Rinforzo x tetto - Dakrand versterking - Räästatugevdus  | | 2 | 28x34 | |
| KFS-1 | Storm protection - Sturmleiste - Latte anti-tempete - Protezione anti vento - Stormverankering / beveiliging - Tormikinnitusliist  | | 4 | 22x45 | |
| | Gable moulding - Giebelleiste - Planche de rive - Finitura per frontale e retro del tetto - Gevellijst - Viilulaud  | | 4 | 18x120 | 4400 |
| HS8 | Screw for gable segment - Schrauben für deckblatt - Vis pour fixation losange de finition - Viti x frontali tetto - Schroef voor gevelpunt segment - Kruvi rombile  | | 4 | 3.5x35 | 2050 |
| HS9 | Screw for flower box - Montagschraube für blumentasten - Vis d assemblage des jardinieres - Viti per fioriera - Montageschroeven voor bloembak - Kruvi lillekasti montaažiks  | | 28 | 3.5x50 | 2150 |
| HS9 | Screw for gable moulding - Schrauben für giebelleiste - Vis pour fixation planche de rive - Vite per fissare finiture davanti e dietro del tetto - Schroef voor gevellijst - Kruvi viilulauale  | | 32 | 3.5x50 | |
| HS12 | Screw for fixing flower box to the walls - Schraube zur Befestigung den blumenkasten - Vis de fixation au mur des jardinieres - Viti per fissare la fioriera alle pareti - Schroeven voor bevestiging bloembak met wand - Kruvi lillekasti kinnitamiseks seinale  | | 3 | 4x40 | |
| HS12 | Screw for fascia boards - Schrauben für traufbretter - Vis pour fixation bandeau de toit - Viti x striscia del tetto - Schroef voor gevellijst - Kruvi räästalauale  | | 18 | 4x40 | |
| HS12 | Screw for roof edge reinforcement - Schrauben für dachrandverstärkung - Vis pour fixation corniere renfort de bord de toit - Viti x rinforzo bordo tetto - Schroef voor dakrand versterking - Kruvi räästatugevdusele  | | 18 | 4x40 | |
| HS18 | Screw for gable - Schrauben für giebel - Vis pour fixation des pignons - Viti per timpano - Schroef voor gevelpunt - Kruvi kelba kinnitamiseks  | | 4 | 5x120 | |
| HS18 | Screw for roof beams - Schrauben für dachbalken - Vis pour fixation pannes de toit - Viti per perline del tetto - Schroef voor gordingen / dakbalken - Kruvi pärlinitele  | | 10 | 5x120 | |
| HS16 | Screw for 1. wall beam - Schraube für 1. bohlenreihe - Vis de fixations 1ere rangée de madriers avec poutrelles de fondations - Vite fissaggio alle fondamenta - Schroef voor 1 wandbalk - Kruvi poollauale  | | 7 | 5x90 | |
| HS16 | Screw for foundation - Schrauben zur befestigung fundament - Vis de fixations des poutrelles de fondations - Viti x fondamenta - Schroef voor fundering - Kruvi alusraamile  | | 14 | 5x90 | |
| NF2 | Zn nail for floor fillet - Zn nägel für fussbodenleiste - Pointe pour corniere de finition du plancher - Chiodi x fissaggio pavimento - Spijker(nagel) voor vloer afdeklijst - Nael põrandaliistule  | | 29 | 1.4x40 | |
| | Flower box - Blumenkasten - Jardiniere - Fioriera - Bloembak - Lillekast  | | 1 | | |
| SH28 | Hammer block - Schlagholz - Calle de frappe - Blocco di legno da usare come cuscinetto quando si usa il martello - Slagklos - Löögiklots  | | 1 | | |
| SFS | Nut for storm protection - Schraubenmutter für sturmleiste - Ecrou pour latte anti-tempete - Dado x asta protezione vento - Moer voor stormverankering - Mutter tormikinnitusliistule  | | 8 | D6 | |
| NF4 | Zn nail for roof - Zn nägel für dachbretter - Pointe pour fixation voliges de toit - Chiodi x perline tetto - Spijker(nagel) voor dakhout - Nael katuselauale  | | 416 | 2x50 | |
| NF4 | Zn nail for floor - Zn nägel für fussbodenbretter - Clous pour plancher - Chiodi x perline pavimento - Spijker(nagel) voor vloer - Nael põrandalauale  | | 287 | 2x50 | |
| NF5 | Zn nail for roofing felt fillet - Zn nägel für dachpappenleiste - Pointe pour baguette de fixation feutre bitumeux - Chiodi x carta bituminosa x tetto - Spijker(nagel) voor asfaltpapier afdeklijst - Papiliistunael  | | 20 | 2x40 | |

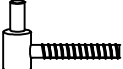
| Pos | 06.09.2016 Piece list - Stückliste - Liste des pièces - Elementi - Stuklijst - Tükítabel 882x990 AK.1.106.SSP.a SGC | 1/1 | Q | P (mm) | L (mm) |
|-----|---|---|---|-----------|-----------|
| | <p data-bbox="263 152 1284 183">Glass size - Glasgröße - Taille de la vitre - Misura del vetro - Glas afmeting - Klaasi mõõt: 738x846 mm</p>   <p data-bbox="1369 347 1492 376">782x890 mm</p> | | | | |
| FS1 | Window handle fittings - Fenstergriff - Poignée de fenetre - Maniglia c/ferramenta - Raamhendel -/grendel -/klink - Aknalink | | 1 | | |
| FSP | Bolt for window handle fittings - Bolzen für fenstergriff beschlag - Vis pour fixation poignée de fenetre - Bullone x apertura manuale finestra - Schroef voor raamhendel - Akna käepideme polt |  | 2 | | |
| HS1 | Screw for georgian bars - Schraube für sprossen - Vis pour croisillons - Viti per unire la griglia georgiana della finestra - Schroeven voor raamverdeling - Kruvi akna petfeliistule |  | 6 | 2.5x20 | |

| Pos | 13.01.2017 | Piece list - Stückliste - Liste des pièces - Elementi - Stuklijst - Tükítabel 1494x1850 TUK.2.056.SVP.MMc SGC | 1/1 | Q | P (mm) | L (mm) |
|------|--|--|-----|--------|-----------|-----------|
| | | Glass size - Glasgröße - Taille de la vitre - Misura del vetro - Glas afmeting - Klaasi mõõt: 514x855 mm | | | | |
| | |   <p>1394x1768 mm</p> | | | | |
| HS1 | Screw for georgian bars - Schraube für sprossen - Vis pour croisillons - Viti per unire la griglia georgiana della finestra - Schroeven voor raamverdeling - Kruvi ukse peffeliistule |  | 12 | 2.5x20 | | |
| HS4 | Screw for door fillet - Schraube zur befestigung türleiste - Vis pour fixation baguette d'arret de porte - Viti per massellino della porta - Schroef voor deurlijst - Kruvi ukse kokkuvaltsiliistule |  | 5 | 3x30 | | |
| HS16 | Screw for door jamb - Schraube für türrahmen - Vis de fixation partie haute avec montants du cadre de porte - Viti x fissaggio montanti porte - Schroef voor deurkozijn - Kruvi ukse lengile |  | 4 | 5x90 | | |
| HS25 | Screw for doorstep - Schrauben für swelle - Vis pour fixation barre de seuil - Vite per soglia della porta - Schroef voor deurdorpel - Kruvi lävepakule |  | 3 | 4.5x65 | | |
| TL4 | Door handle fittings - Türgriff - Poignée de porte - Maniglie - Deurhendel / klink - Ukse käepide VU |  | 1 | | | |
| TL5 | Set of door lock covers - Schlossblenden - Set de garnitures de porte - Copertura serrature - Slot sluitplaat set - Ukse lukuplaat |  | 1 | | | |
| | Cylinder lock - Zylinderschloss - Barillet de porte - Serratura - Cylinder slot - Ukse lukusüdamik |  | 1 | 30x35 | | |
| | Male bolt hinge for door - Türband - Partie male de paumelle de porte - Cerniera anube x porta - Scharnier bout - Ukse polthing isane |  | 6 | | | |
| | Striker for barrel bolt - Hülse für grendelriegel - Gache au sol du targette - Boccola per fermo della porta - Huls voor vergrendelingsschuif - Vasturaud ukse servariivile |  | 2 | | | |