

Domeo 6
Art. Nr. 4424919
1/27

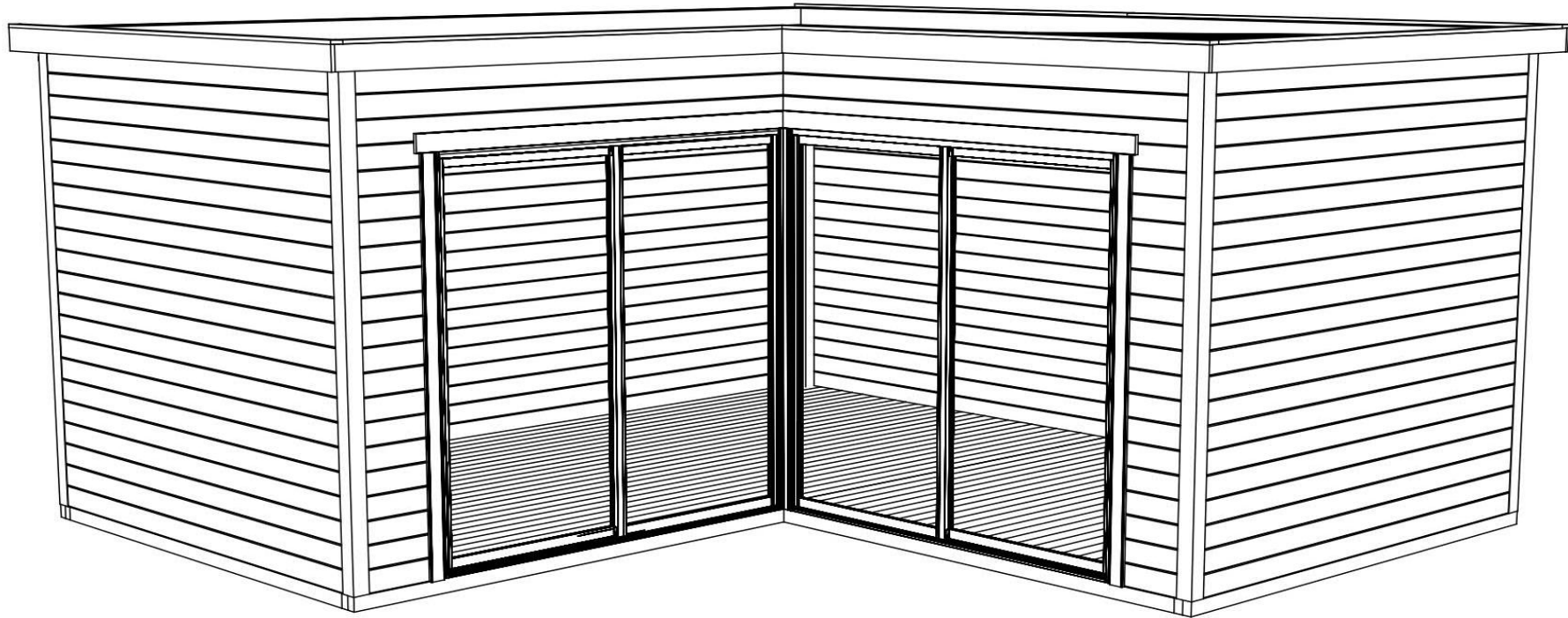

Groundplan - Grundplan - Plan de masse -
Planimetria - Plattegrond - Põhiplaan

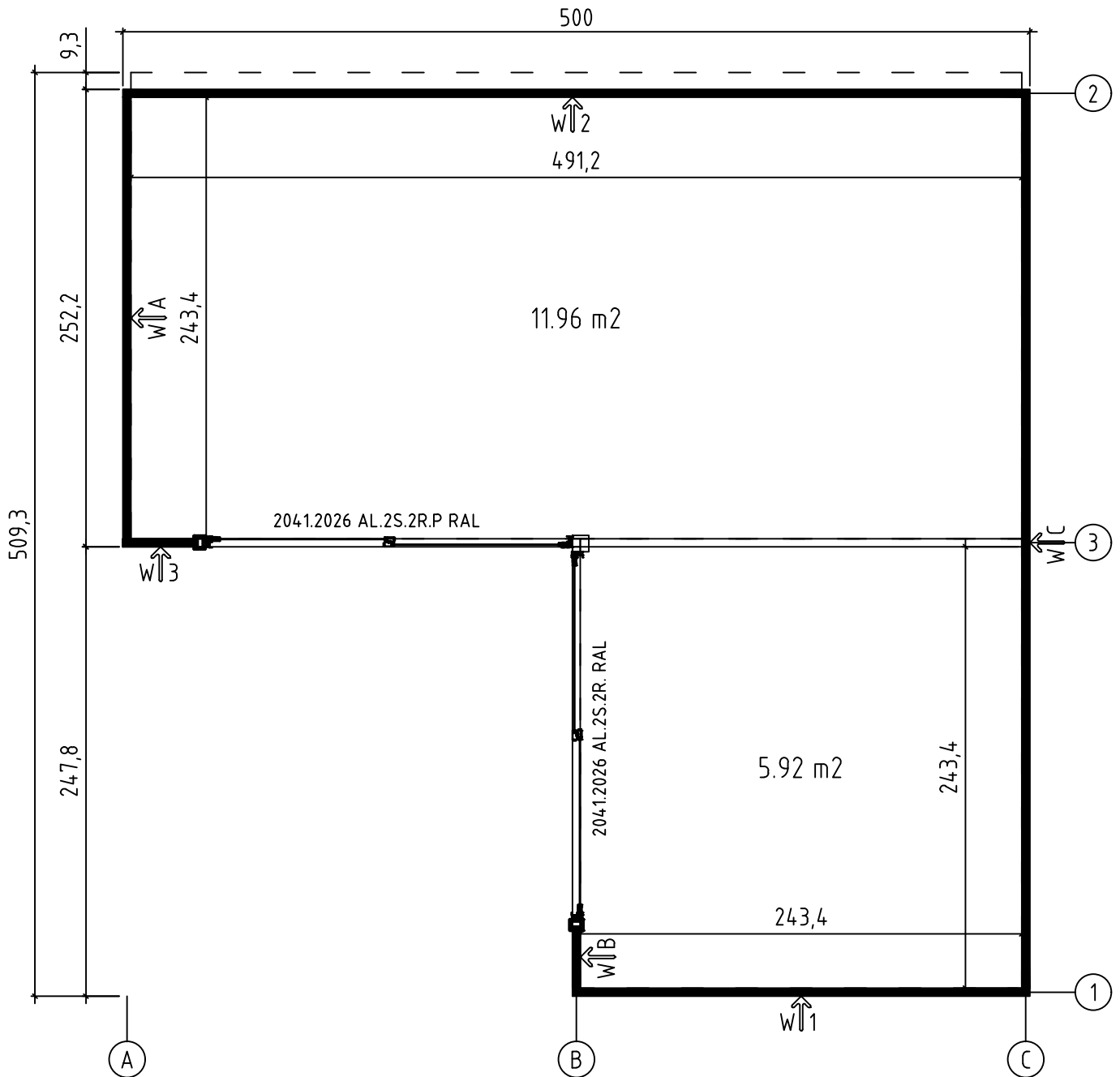

Foundation - Fundament - Fondation - Fundamenta - Fundering -
Immutatud alusraam

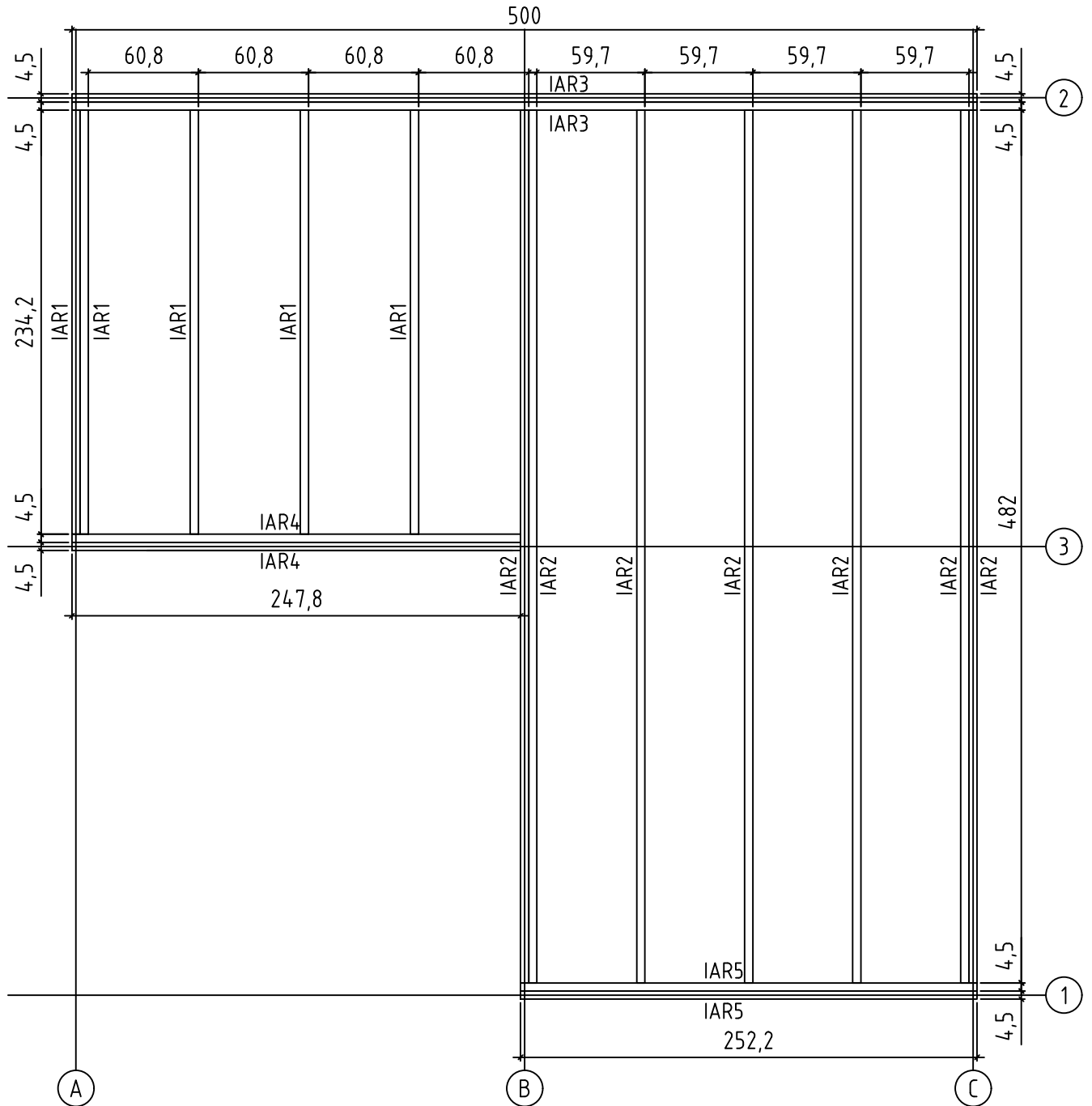

Art. Nr. 4424919

Floor boards - Fussbodenbretter - Plan pose plancher - Pavimento
- Vloerhout - Põrandalaudis

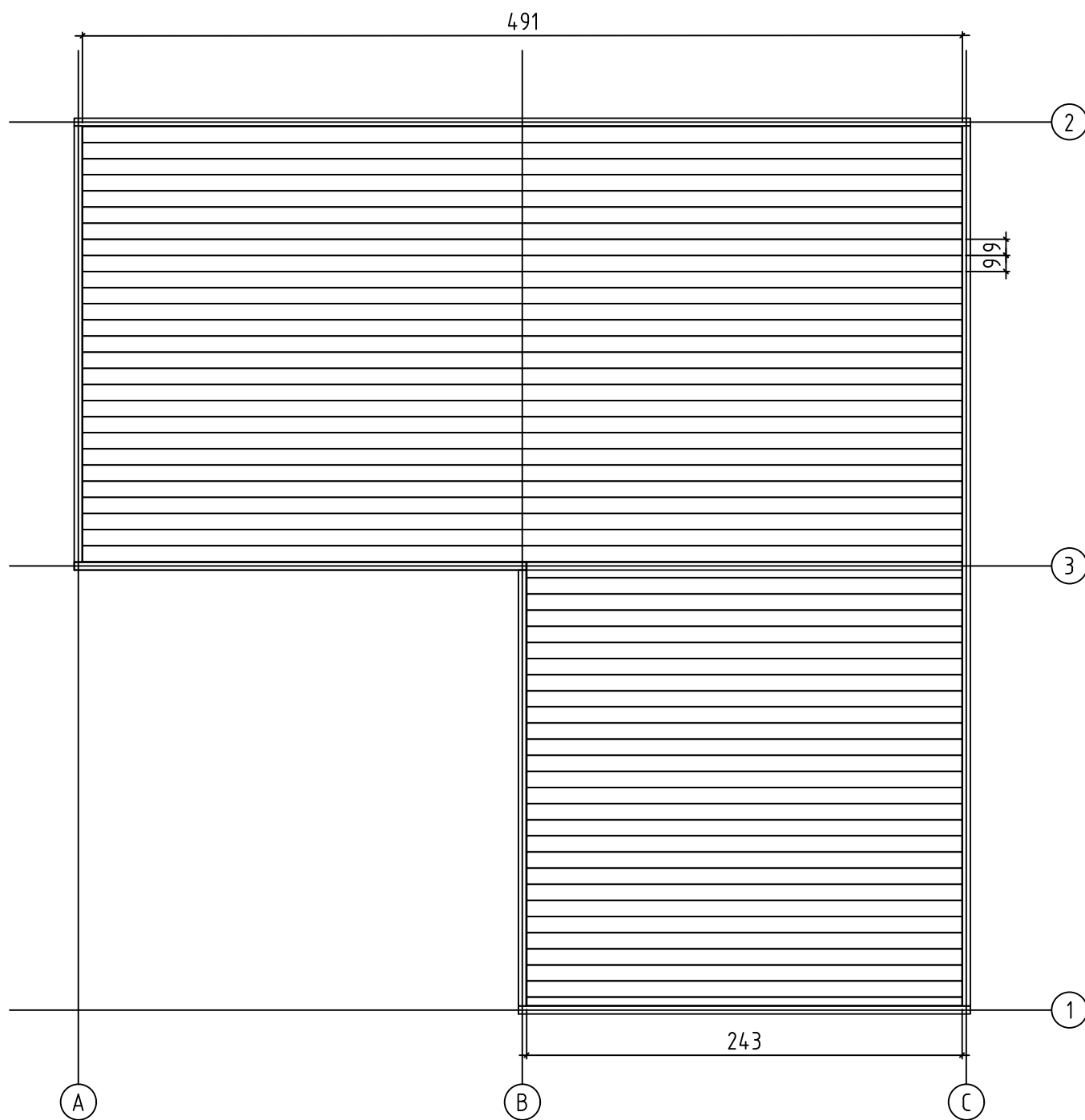

Without tongue - Ohne feder - Madrier de finition -
Finale in legno - Zonder veer - Punnita

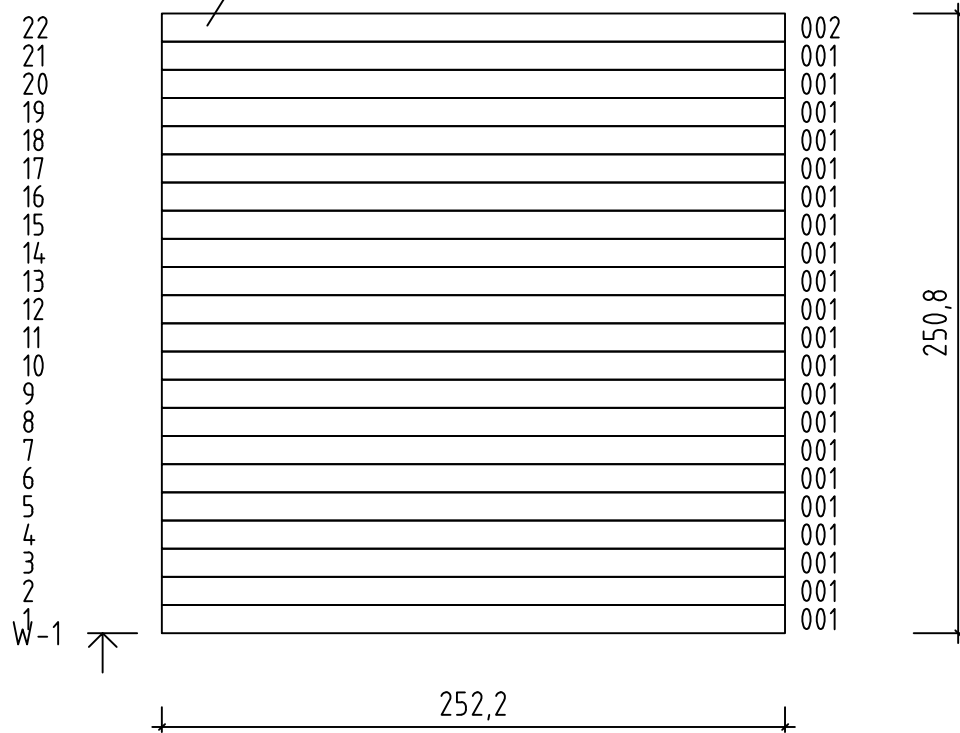



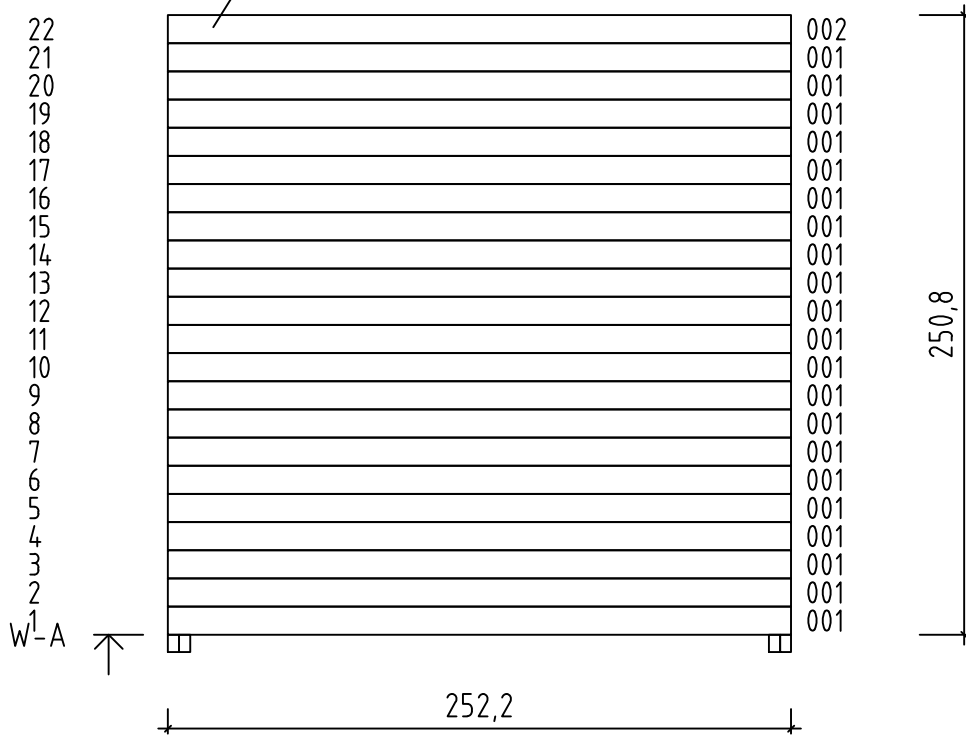



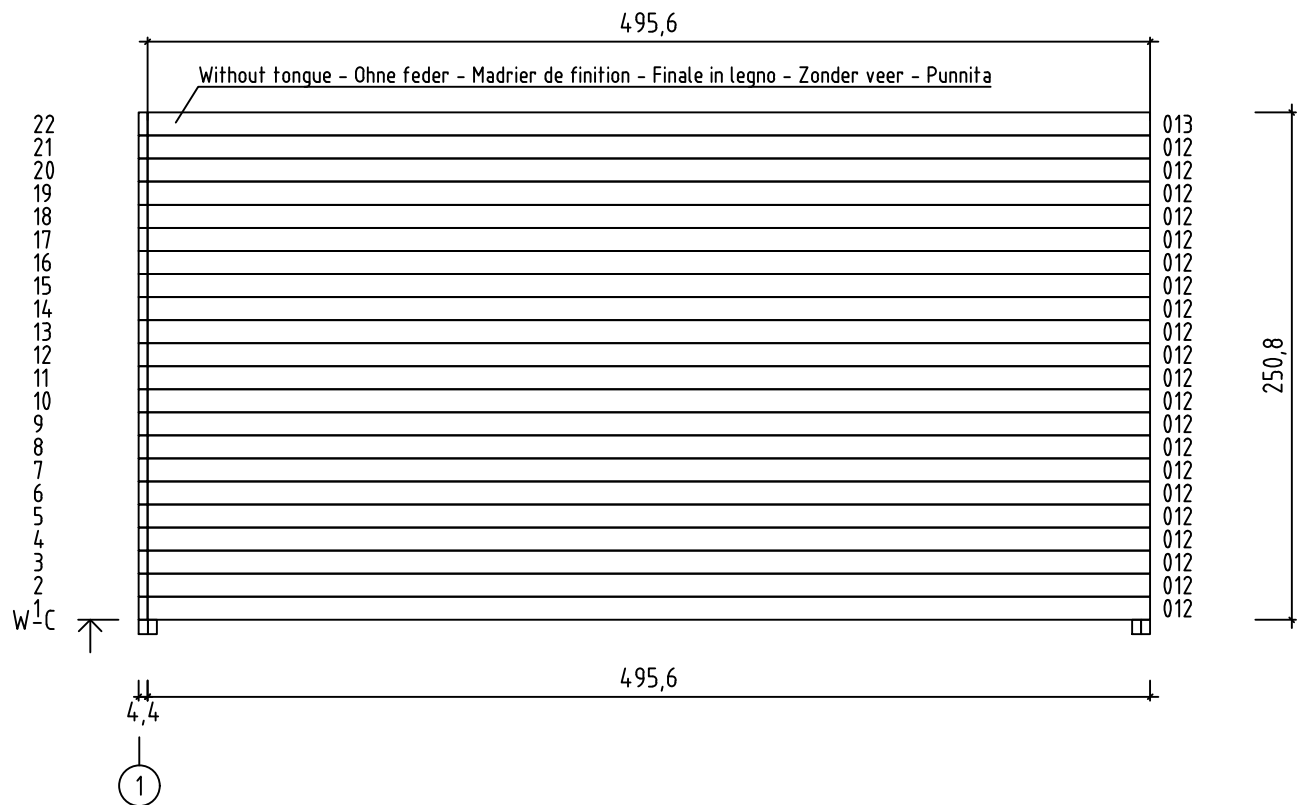
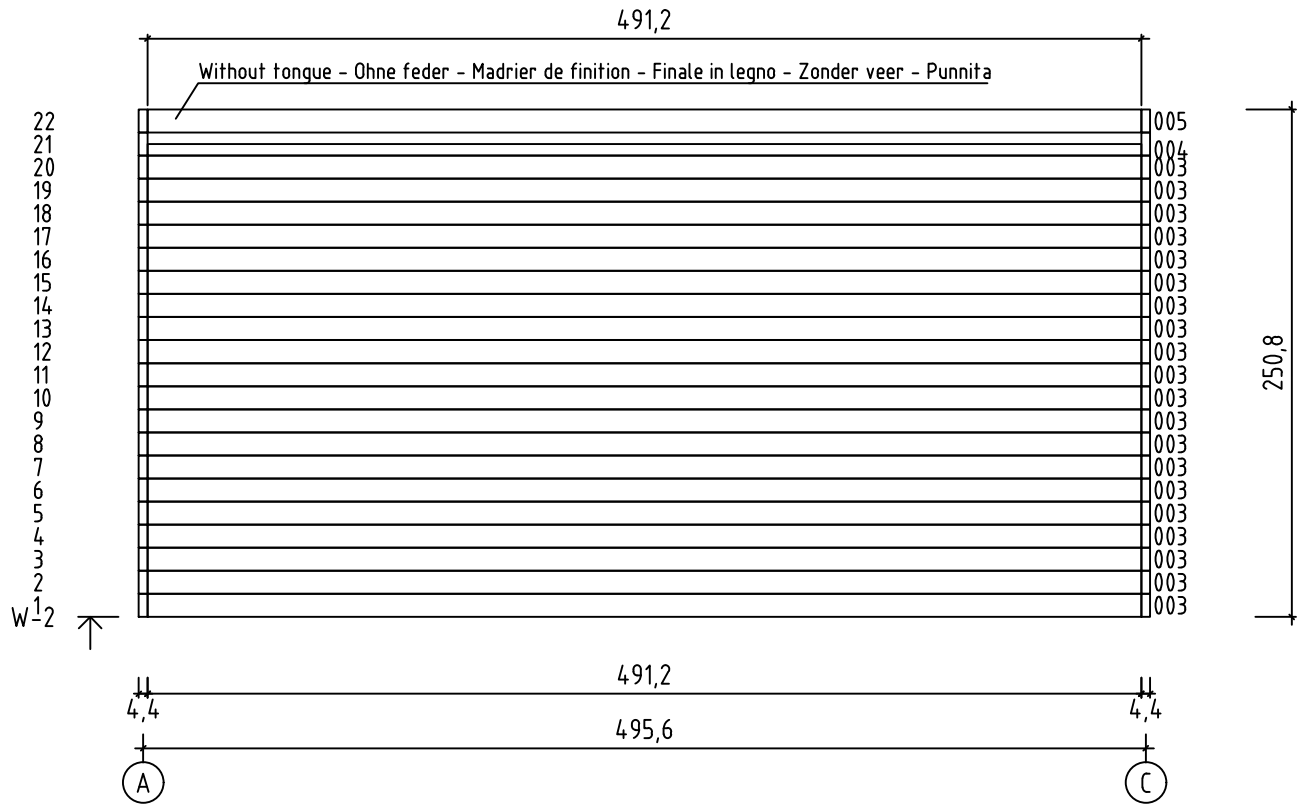

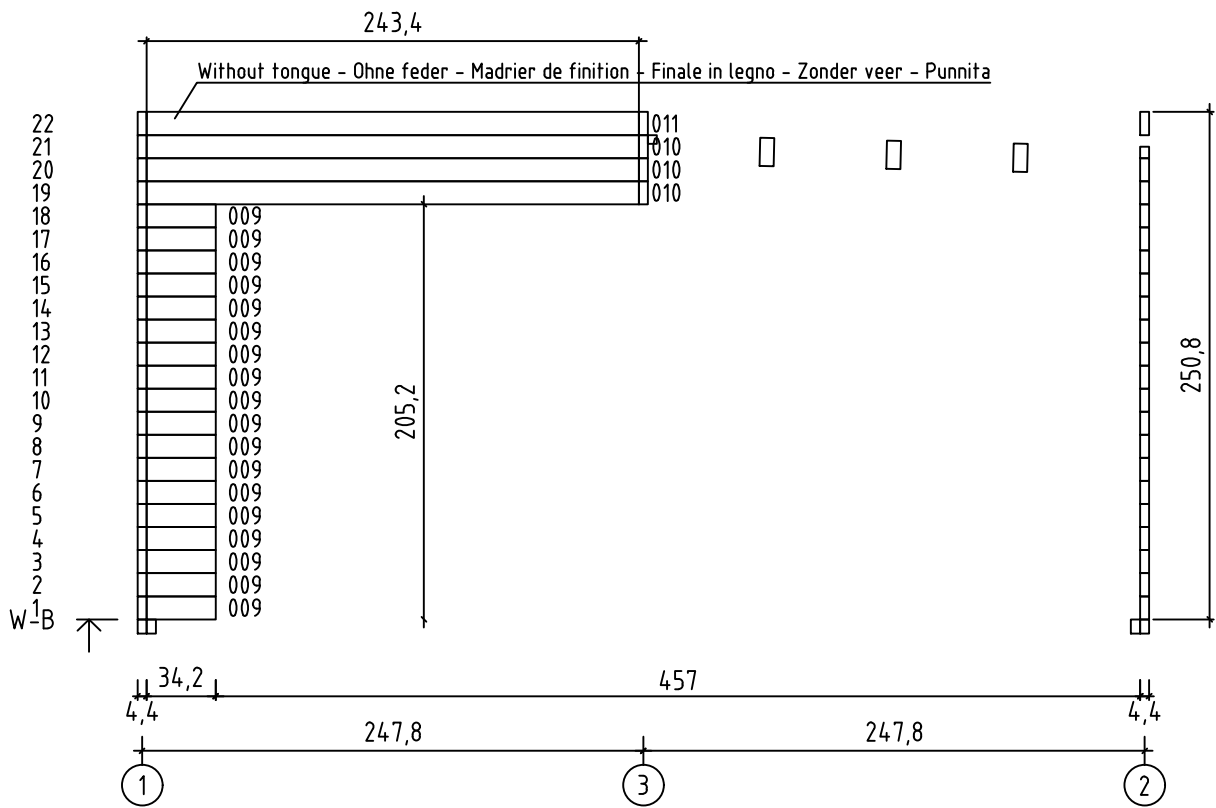
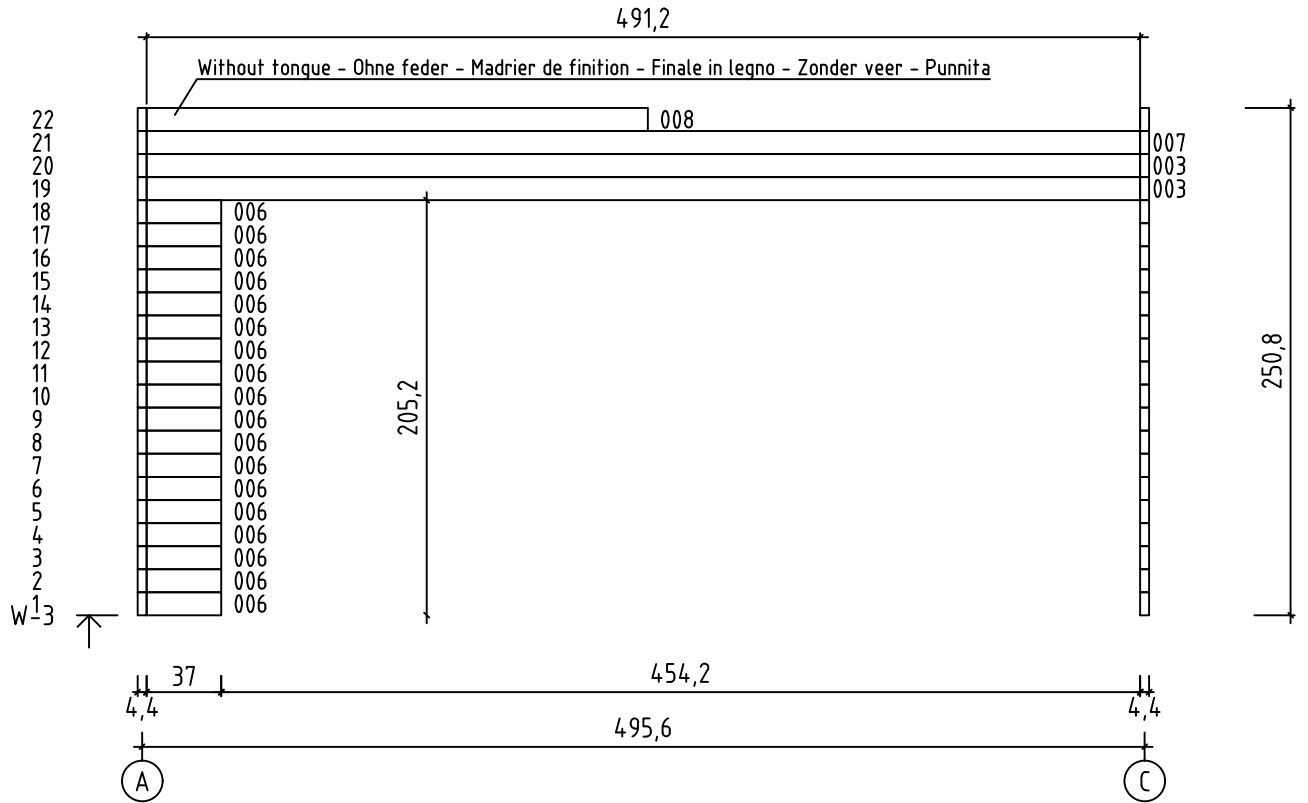

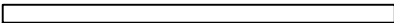

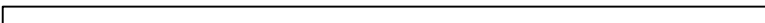
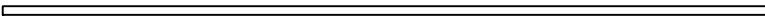

Without tongue - Ohne feder - Madrier de finition -
Finale in legno - Zonder veer - Punnita

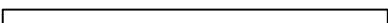

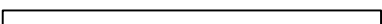

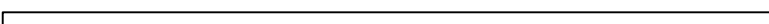
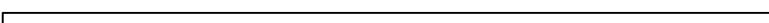
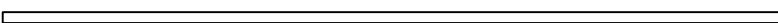
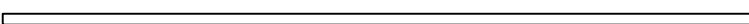
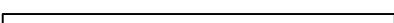
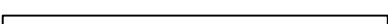
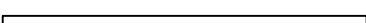

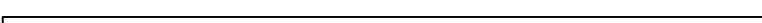
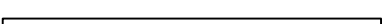









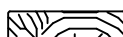
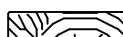
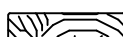
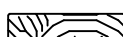

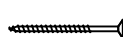

Art. Nr. 4424919





Pos	12.03.2020 Piece list - Stückliste - Liste des pièces - Elementi - Stuklijst - Tükítabel Art. Nr. 4424919	8/27	Q	P (mm)	L (mm)
001			42	44x114	2522
002			2	44x114	2522
003			22	44x114	4912
004			1	44x57	4912
005			1	44x114	4912
006			18	44x114	370
007			1	44x114	4912
008			1	44x114	2478
009			18	44x114	342
010			3	44x114	2434
011			1	44x114	2434
012			21	44x114	4956
013			1	44x114	4956
IAR3	Foundation - Fundament - Fondation - Fondamenta - Fundering - Immutatud alusraam 		2	45x70	5000
IAR2	Foundation - Fundament - Fondation - Fondamenta - Fundering - Immutatud alusraam 		7	45x70	4820
IAR5	Foundation - Fundament - Fondation - Fondamenta - Fundering - Immutatud alusraam 		2	45x70	2522
IAR4	Foundation - Fundament - Fondation - Fondamenta - Fundering - Immutatud alusraam 		2	45x70	2478
IAR1	Foundation - Fundament - Fondation - Fondamenta - Fundering - Immutatud alusraam 		5	45x70	2342
RV1	Lath - Pfetten - Linteau - Piccola asse - Gordingen - Roov 		1	44x44	4798
RV2	Lath - Pfetten - Linteau - Piccola asse - Gordingen - Roov 		1	44x44	2294
A-PR1	Roof beam - Dachbalken - Panne de toit - Perlina del tetto - Gordingen / dakbalk - Pärilin 		3	70x140	4904
A-PR2	Roof beam - Dachbalken - Panne de toit - Perlina del tetto - Gordingen / dakbalk - Pärilin 		3	70x140	2426
FB1	Floor boards - Fussbodenbretter - Lame de plancher - Pavimento - Vloerhout - Pörandalaud 		27	90x18	4908

Pos	12.03.2020 Piece list - Stückliste - Liste des pièces - Elementi - Stuklijst - Tükitalabel Art. Nr. 4424919	9/27	Q	P (mm)	L (mm)
FB2	Floor boards - Fussbodenbretter - Lame de plancher - Pavimento - Vloerhout - Põrandalaud 		28	90x18	2430
DB1	Roof boards - Dachbretter - Voliges - Perlina per tetto - Dakhout - Katuselaud 		55+1	90x18	2571
DB2	Roof boards - Dachbretter - Voliges - Perlina per tetto - Dakhout - Katuselaud 		28+1	90x18	2479
	Floor fillet - Fussbodenleiste - Corniere de finition du plancher - Finitura per pavimento (battisco pa) - Vloerafwerkljst - Põrandaliist 			18x18	20
DPL1	Roofing felt fillet - Dachpappenleiste - Baguette de fixation du feutre bitumeux - Asse per fissaggio guaina bituminosa - Afdeklijst asfaltpapier - Katusepapiliist 		1	18x58	2420
DPL2	Roofing felt fillet - Dachpappenleiste - Baguette de fixation du feutre bitumeux - Asse per fissaggio guaina bituminosa - Afdeklijst asfaltpapier - Katusepapiliist 		1	18x58	2536
DPL3	Roofing felt fillet - Dachpappenleiste - Baguette de fixation du feutre bitumeux - Asse per fissaggio guaina bituminosa - Afdeklijst asfaltpapier - Katusepapiliist 		1	18x58	2594
DPL4	Roofing felt fillet - Dachpappenleiste - Baguette de fixation du feutre bitumeux - Asse per fissaggio guaina bituminosa - Afdeklijst asfaltpapier - Katusepapiliist 		2	18x58	2602
DPL5	Roofing felt fillet - Dachpappenleiste - Baguette de fixation du feutre bitumeux - Asse per fissaggio guaina bituminosa - Afdeklijst asfaltpapier - Katusepapiliist 		1	18x58	2718
FL1	Fillet - Leiste - Lattes - Massellino di guarnizione per ringhiera - Ljst - Liist 		1	28x34	342
RS2	Railing strip - Begrenzungsleiste - Rembarde - Sbarra - Afscheidingslijst - Piirdelaud 		2	18x70	1982
RS4	Railing strip - Begrenzungsleiste - Rembarde - Sbarra - Afscheidingslijst - Piirdelaud 		2	18x70	2000
RS7	Railing strip - Begrenzungsleiste - Rembarde - Sbarra - Afscheidingslijst - Piirdelaud 		2	18x90	2116
RS8	Railing strip - Begrenzungsleiste - Rembarde - Sbarra - Afscheidingslijst - Piirdelaud 		2	18x90	2126
P1	Post - Pfosten - Poteau - Piede registrabile - Stijl - Post 		2	70x70	2337
P2	Post - Pfosten - Poteau - Piede registrabile - Stijl - Post 		1	70x70	2394
P3	Post - Pfosten - Poteau - Piede registrabile - Stijl - Post 		2	70x70	2452
P4	Post - Pfosten - Poteau - Piede registrabile - Stijl - Post 		1	90x90	2052
DRV1	Roof edge reinforcement - Dachrandverstärkung - Corniere de renfort de bord de toit - Rinforzo x tetto - Dakrand versterking - Räästafugevdus 		1	80x44	2398
DRV2	Roof edge reinforcement - Dachrandverstärkung - Corniere de renfort de bord de toit - Rinforzo x tetto - Dakrand versterking - Räästafugevdus 		2	80x44	2478
DRV3	Roof edge reinforcement - Dachrandverstärkung - Corniere de renfort de bord de toit - Rinforzo x tetto - Dakrand versterking - Räästafugevdus 		1	80x44	2558
DRV4	Roof edge reinforcement - Dachrandverstärkung - Corniere de renfort de bord de toit - Rinforzo x tetto - Dakrand versterking - Räästafugevdus 		4	80x44	2602
FF2	Fixing fillet - Fixierungsleiste - Profil de fixation - Massello di fissaggio - Bevestiging lijstwerk - Tenderliist 		2	15x45	2026

Pos	12.03.2020 Piece list - Stückliste - Liste des pièces - Elementi - Stuklijst - Tükítabel Art. Nr. 4424919	10/27	Q	P (mm)	L (mm)
FF	Fixing fillet - Fixierungsleiste - Profil de fixation - Massello di fissaggio - Bevestiging lijstwerk - Tenderliist		2	18x44	2030
FF3	Fixing fillet - Fixierungsleiste - Profil de fixation - Massello di fissaggio - Bevestiging lijstwerk - Tenderliist		2	38x46	1980
FF4	Fixing fillet - Fixierungsleiste - Profil de fixation - Massello di fissaggio - Bevestiging lijstwerk - Tenderliist		2	38x46	2026
FL2	Fillet - Leiste - Lattes - Massellino di guarnizione per ringhiera - Lijst - Liist		2	44x44	330
GL1	Gable moulding - Giebelleiste - Planche de rive - Finitura per frontale e retro del tetto - Gevellijst - Viilulaud		2	18x120	2478
GL2	Gable moulding - Giebelleiste - Planche de rive - Finitura per frontale e retro del tetto - Gevellijst - Viilulaud		2	18x120	2580
GL3	Gable moulding - Giebelleiste - Planche de rive - Finitura per frontale e retro del tetto - Gevellijst - Viilulaud		2	18x120	2598
GL4	Gable moulding - Giebelleiste - Planche de rive - Finitura per frontale e retro del tetto - Gevellijst - Viilulaud		1	18x120	2682
GL5	Gable moulding - Giebelleiste - Planche de rive - Finitura per frontale e retro del tetto - Gevellijst - Viilulaud		1	18x120	2718
HS32	Screw for door jamb - Schraube für türrahmen - Vis de fixation partie haute avec montants du cadre de porte - Viti x fissaggio montanti porte - Schroef voor deurkozijn - Kruvi ukse lengile		8	4x25	
HS14	Screw for wall details - Schraube für wand details - Vis pour mur details - Viti per elementi della porta - Schroef voor wand details - Kruvi seinte montaažiks		460	4.5x80	
HS12	Screw for doorstep - Schrauben für swelle - Vis pour fixation barre de seuil - Vite per soglia della porta - Schroef voor deurdorpel - Kruvi lävepakule		6	4x40	
HS12	Screw for metal corner - Holzschraube für metallwinkel - Vis de fixation des cornieres en métal - Viti per fissare suadretta di metallo di giunzione - Schroef voor metalen hoek - Kruvi nurgikule		20	4x40	
HS12	Screw for covering moulding - Schrauben für deckungsprofil - Vis de fixation profils horizontaux haut intérieur et extérieur d'encadrement de porte - Vite per cornice di copertura - Schroef voor afdekprofiel - Kruvi piirdelauale		32	4x40	
HS12	Screw for beam holder - Schrauben für balkenhalter - Vis de fixation support "u" galvanisé - Vite per trave di sostegno - Schroef voor bevestiging balkhouder (gordingschoen) - Kruvi talakingale		144	4x40	
HS12	Screw for fixing fillet of door and window - Schrauben für fixierungsleiste - Vis pour profil vertical de fixation pour ouvertures des fenetres et portes - Viti per massello di fissaggio - Schroeven voor bevestiging van deur en raam lijsten - Kruvi tenderliistudele		36	4x40	
HS12	Screw for door jamb - Schraube für türrahmen - Vis de fixation partie haute avec montants du cadre de porte - Viti x fissaggio montanti porte - Schroef voor deurkozijn - Kruvi ukse lengile		12	4x40	
HS12	Screw for gable moulding - Schrauben für giebelleiste - Vis pour fixation planche de rive - Vite per fissare finitura davanti e dietro del tetto - Schroef voor gevellijst - Kruvi viilulauale		48	4x40	
HS13	Screw for wall details - Schraube für wand details - Vis pour mur details - Viti per elementi della porta - Schroef voor wand details - Kruvi seinadetailile		36	4x60	
HS33	Screw for door jamb - Schraube für türrahmen - Vis de fixation partie haute avec montants du cadre de porte - Viti x fissaggio montanti porte - Schroef voor deurkozijn - Kruvi ukse lengile		16	5x40	
HS16	Screw for foundation - Schrauben zur befestigung fundament - Vis de fixations des poutrelles de fondations - Viti x fundamenta - Schroef voor fundering - Kruvi alusraamile		44	5x90	
HS16	Screw for post - Schrauben für pfosten - Vis de fixation des poteaux - Viti per inviare - Schroef voor stijlen - Kruvi postile		12	5x90	
HS16	Screw for roof edge reinforcement - Schrauben für dachrandverstärkung - Vis pour fixation corniere renfort de bord de toit - Viti x rinforzo bordo tetto - Schroef voor dakrand versterking - Kruvi räästatugevdusele		40	5x90	

Art. Nr. 4424919

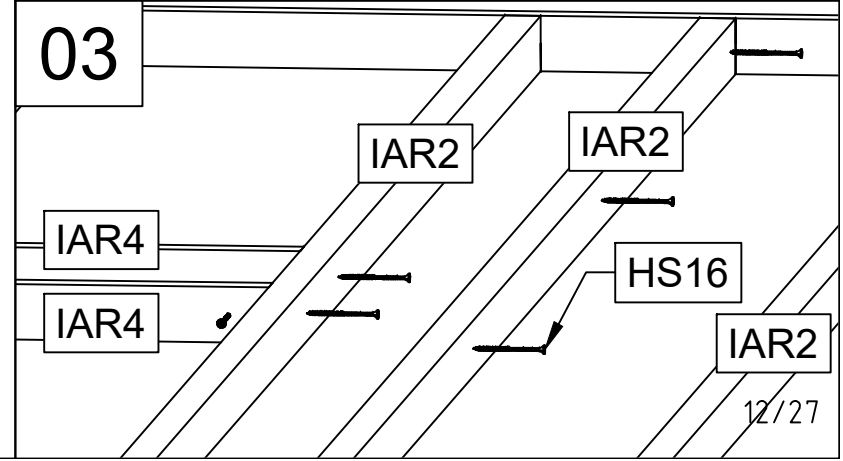
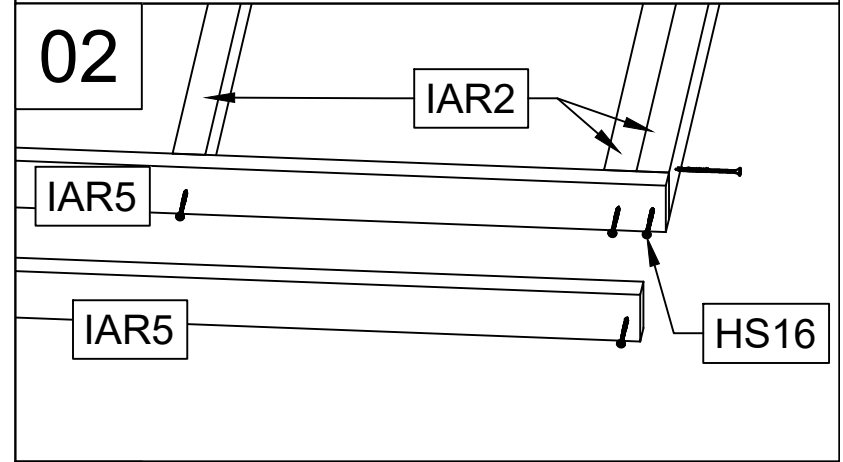
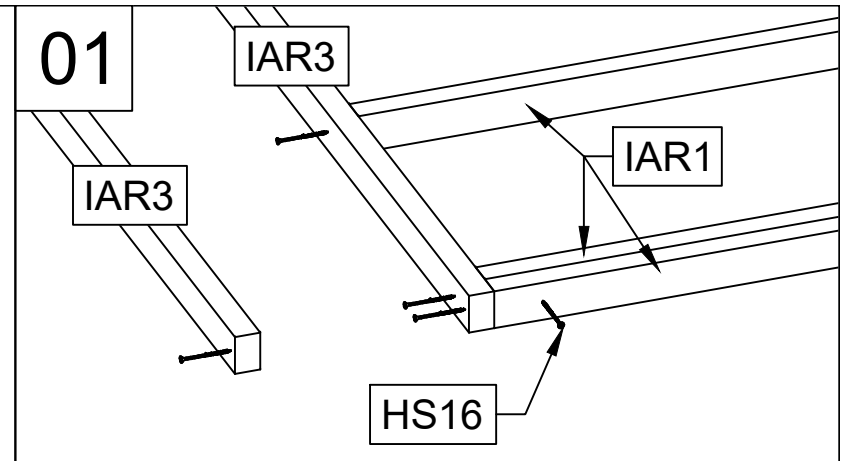
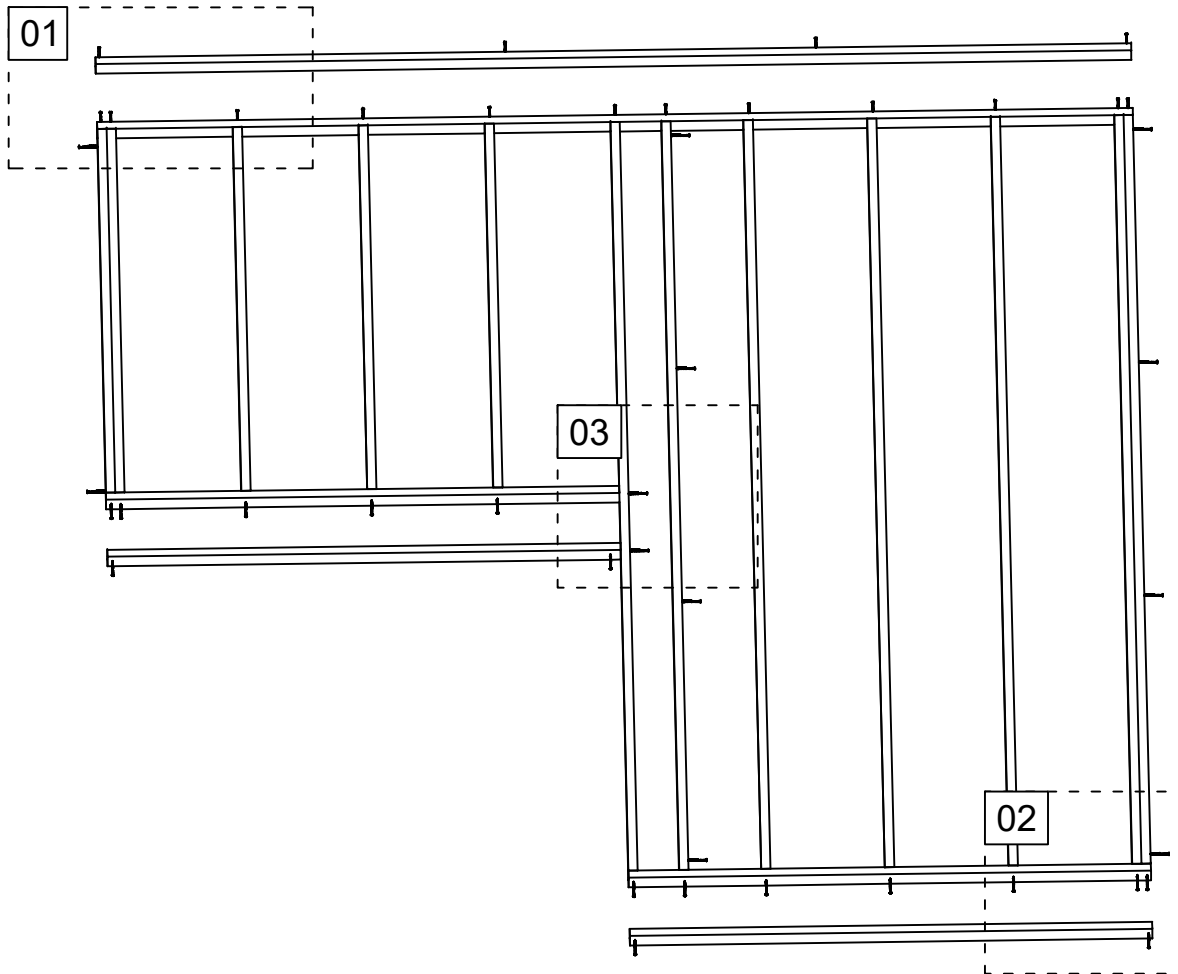

Art. Nr. 4424919

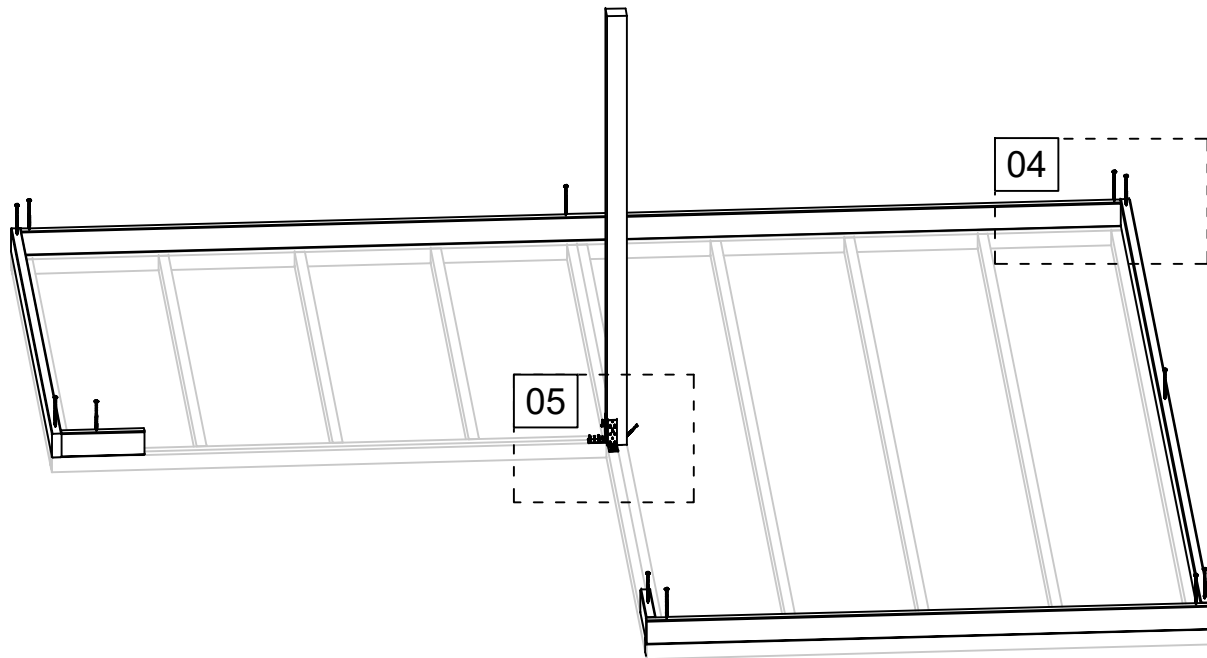

04

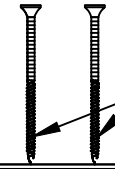

HS22

05

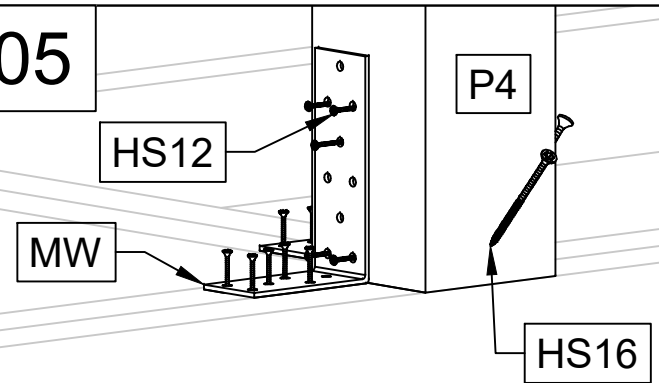

HS12

P4

MW

HS16

05

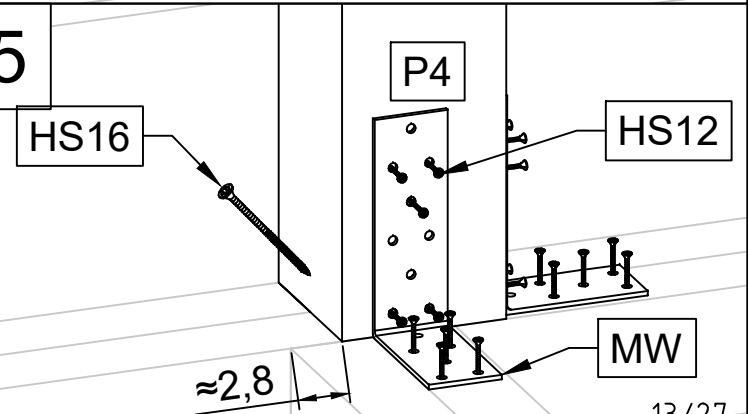

HS16

P4

HS12

MW

≈2,8

Art. Nr. 4424919

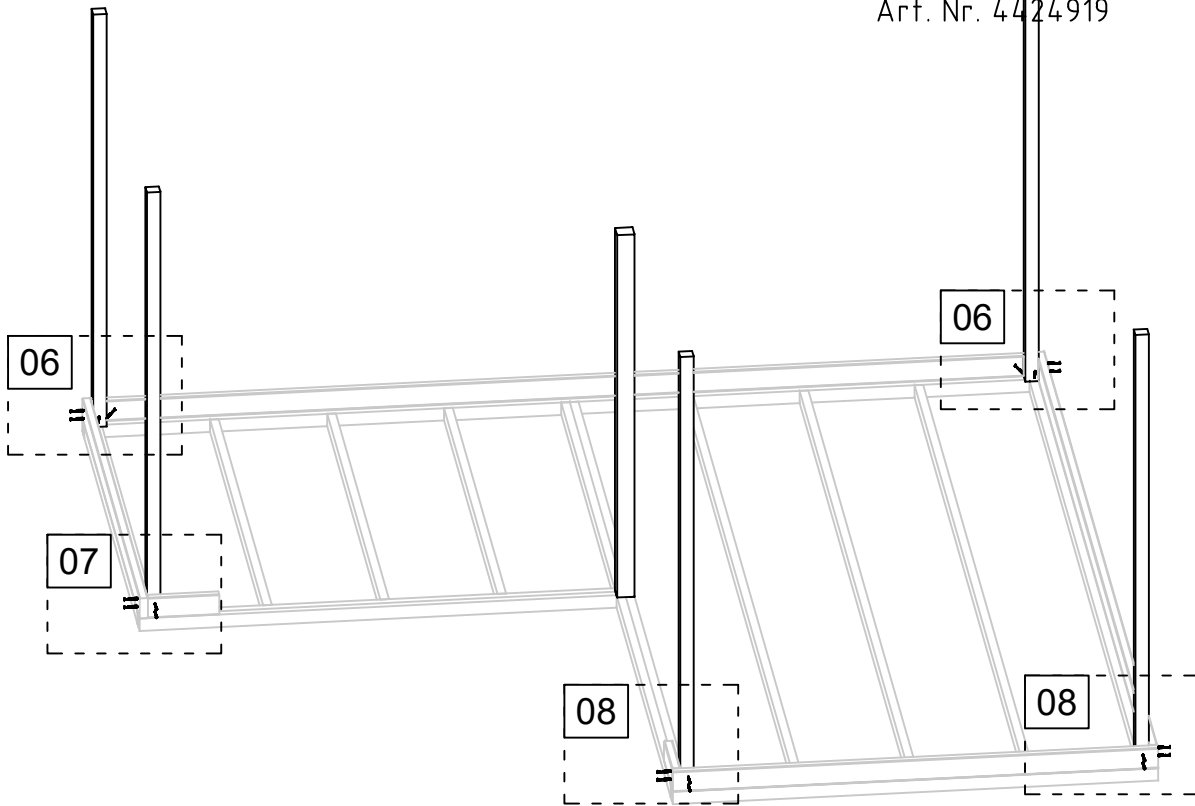

06

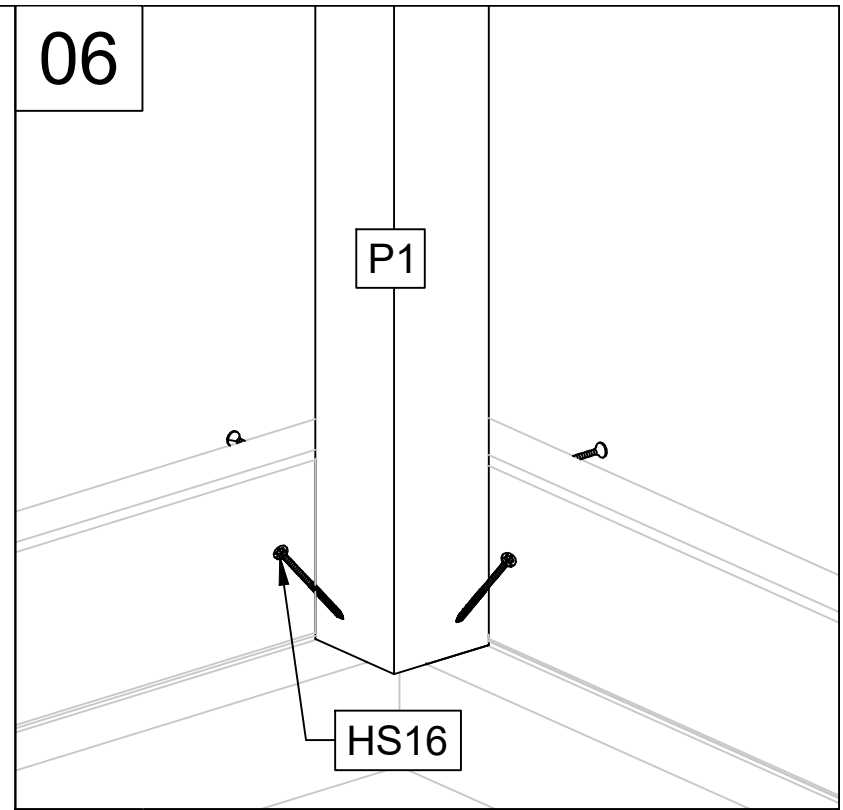

08

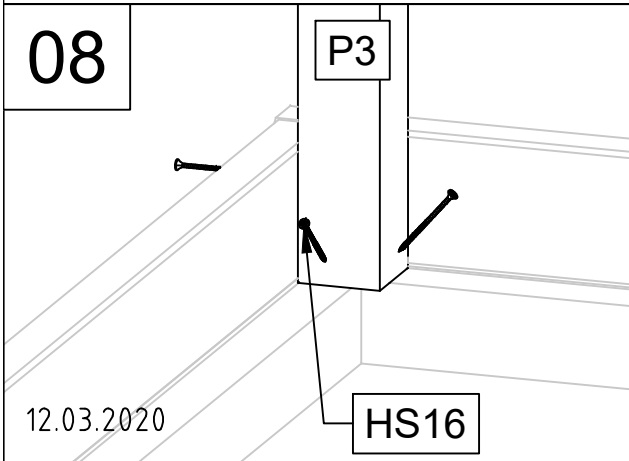

08

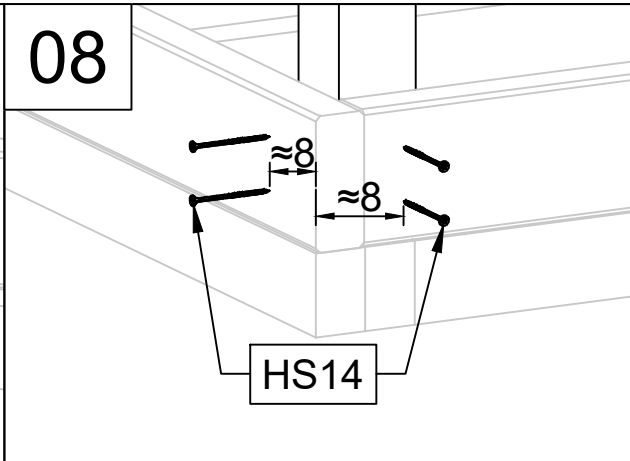

07

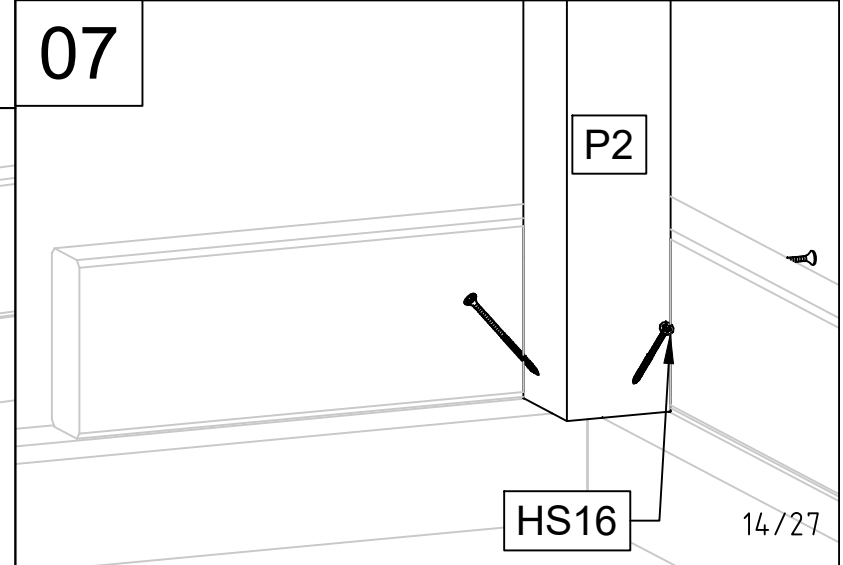

Art. Nr. 4424919

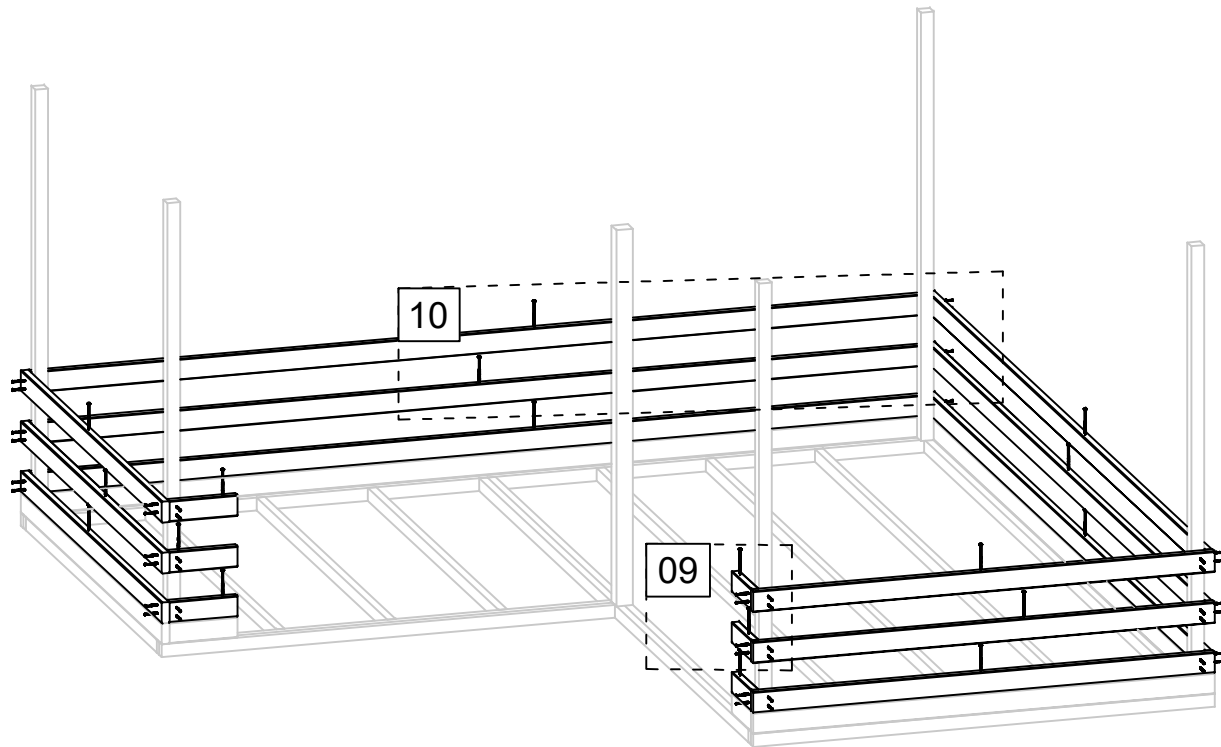

09

HS23

HS14

10

HS14

HS23

Art. Nr. 4424919

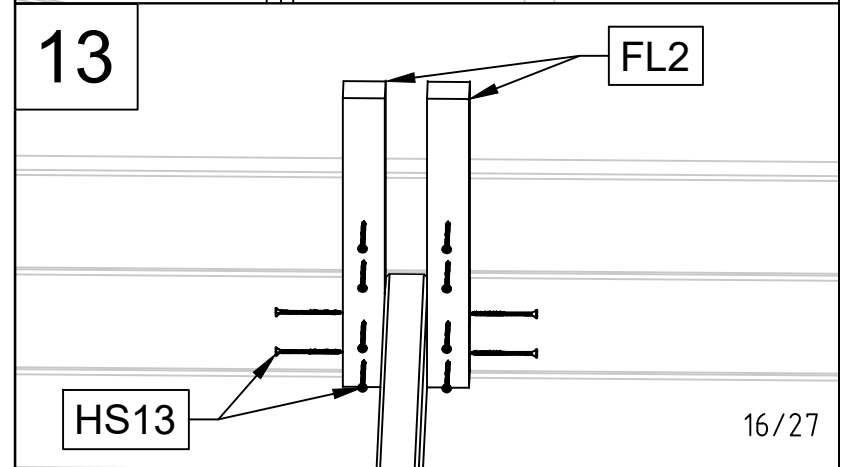
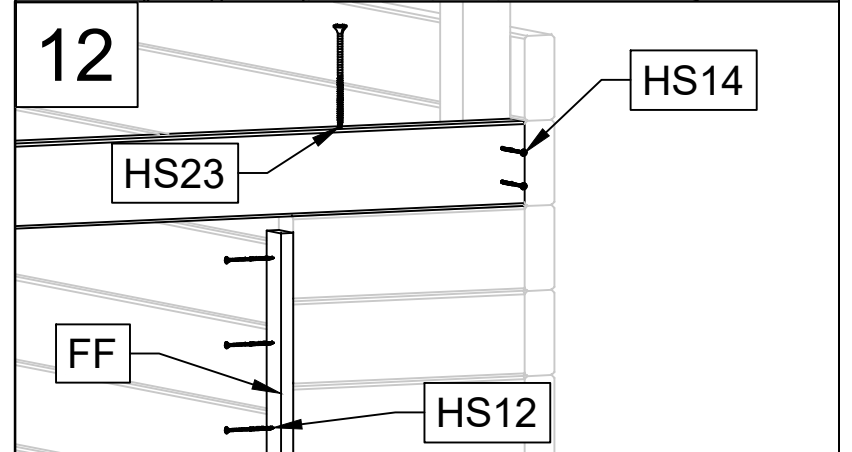
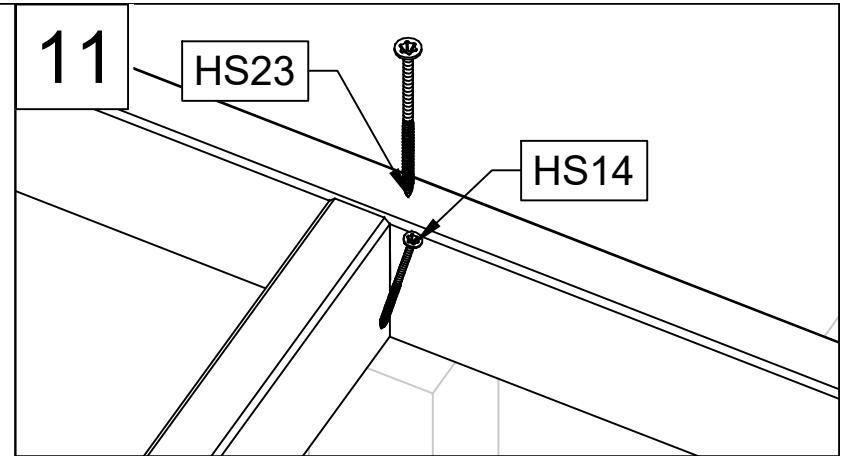
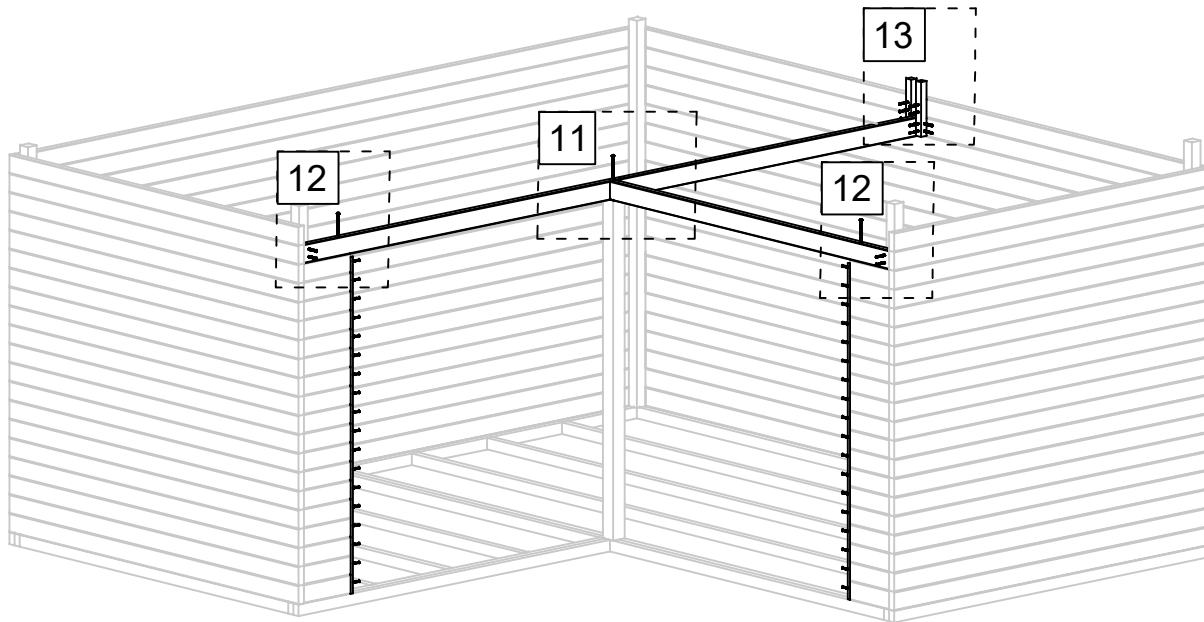

Art. Nr. 4424919

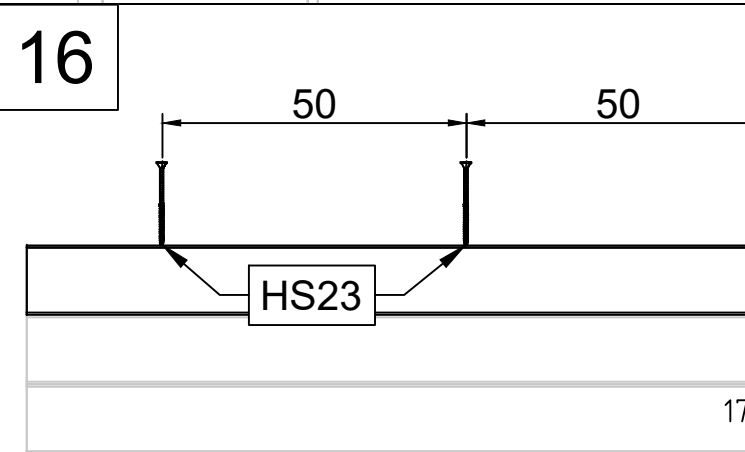
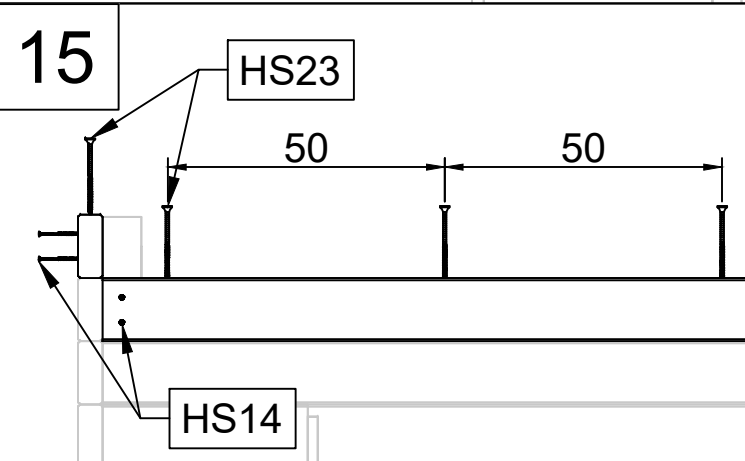
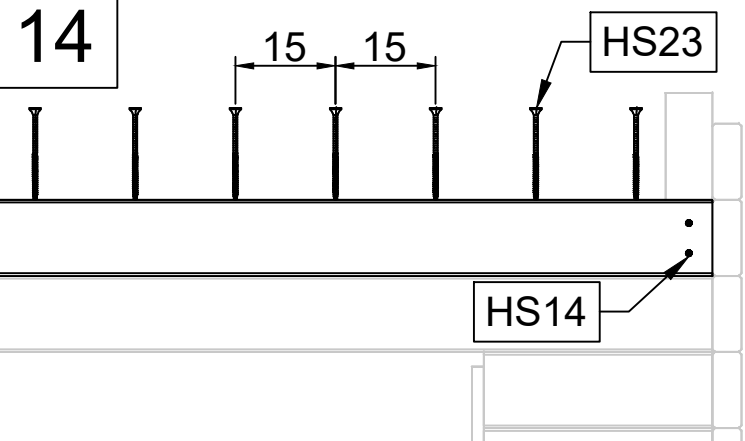
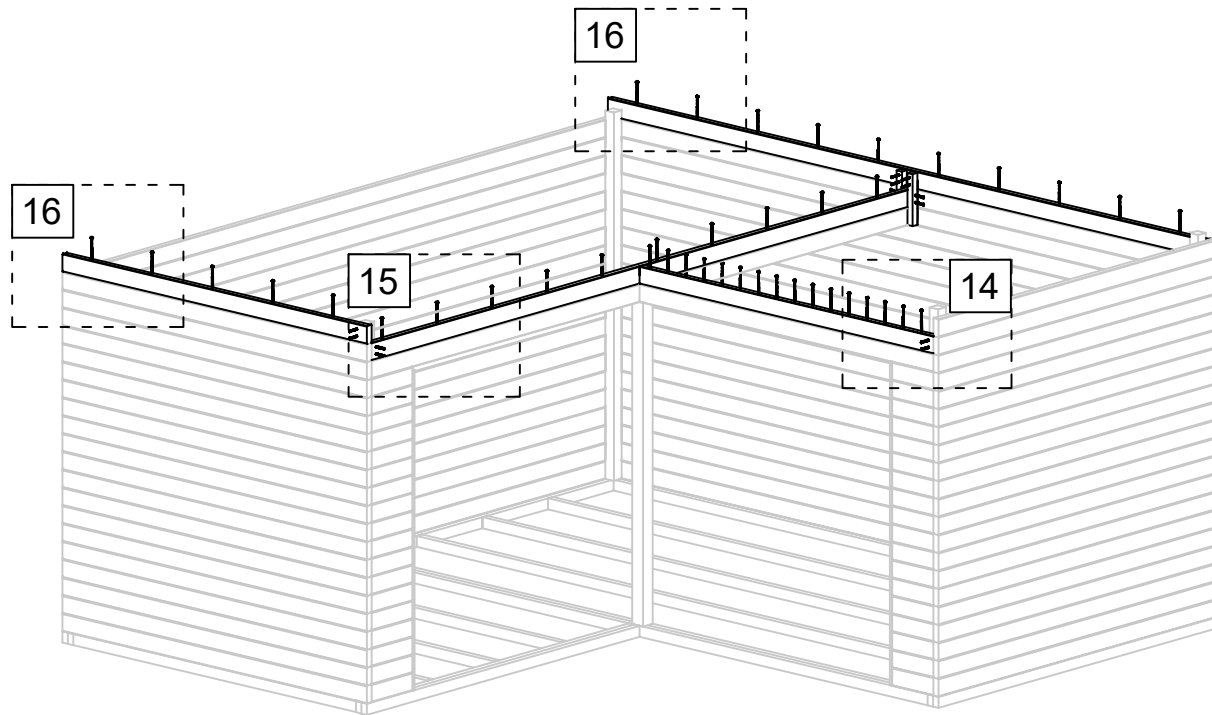

Art. Nr. 4424919

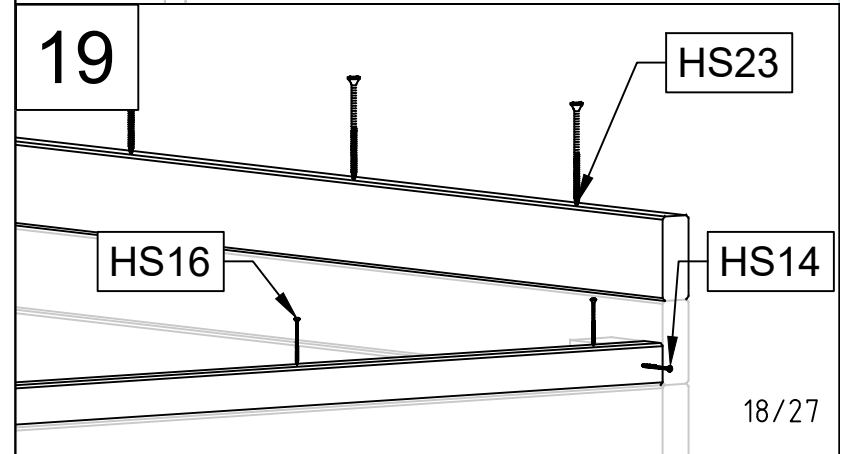
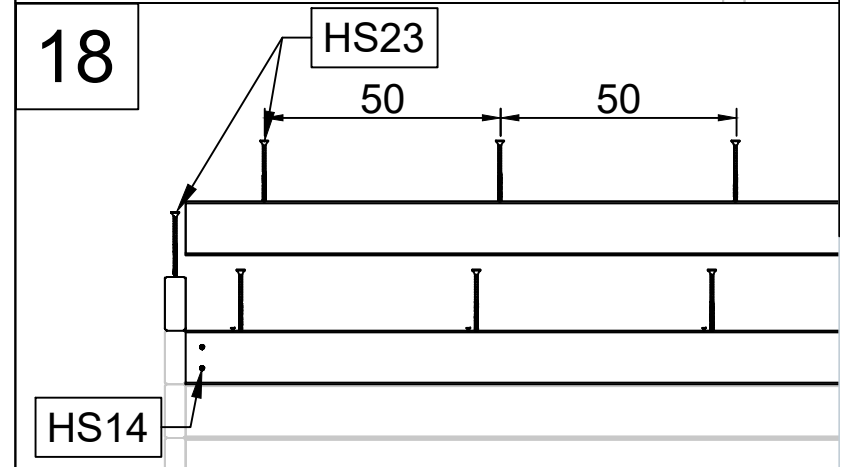
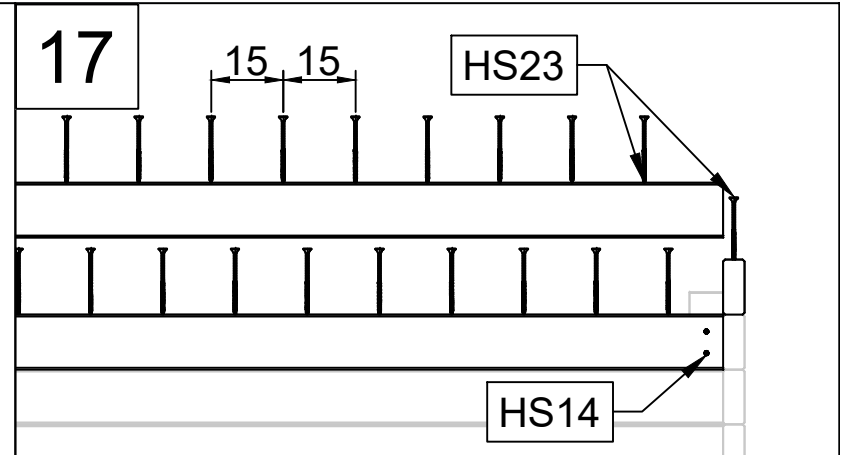
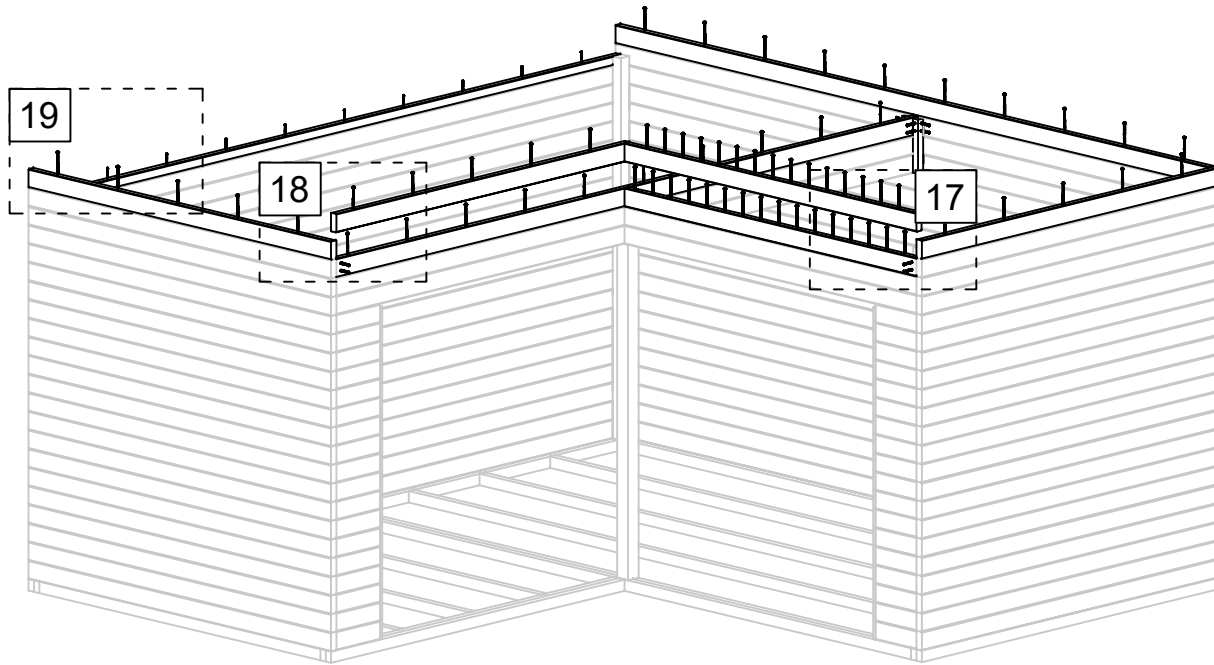

12.03.2020

18/27

Art. Nr. 4424919

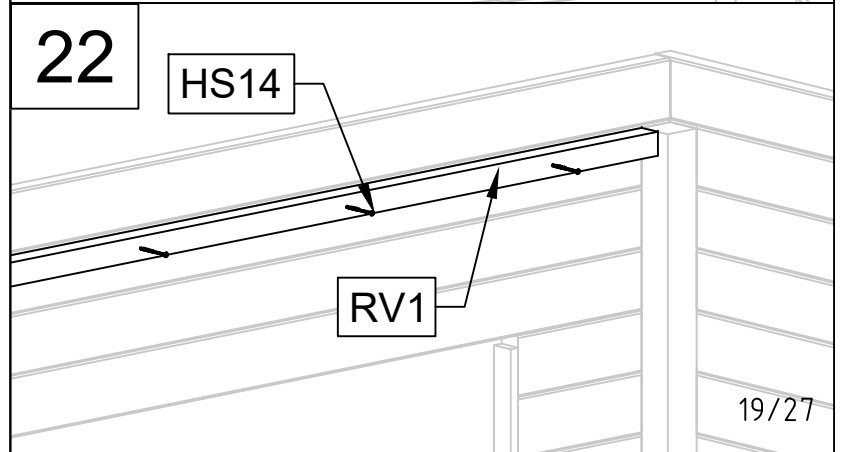
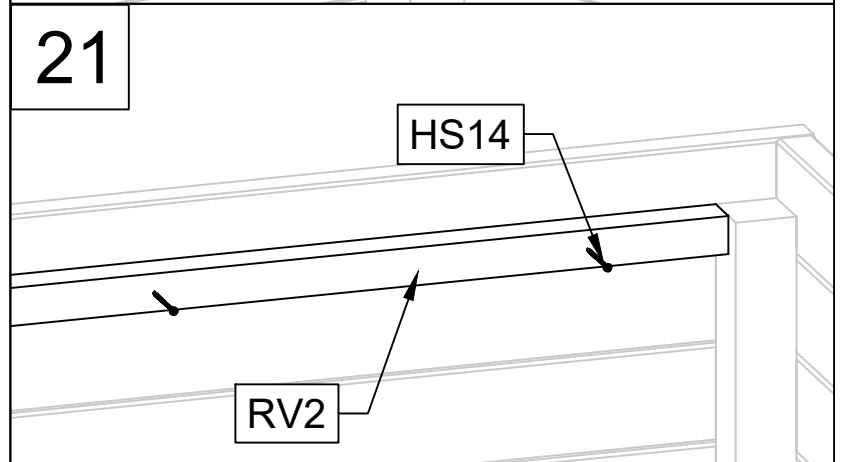
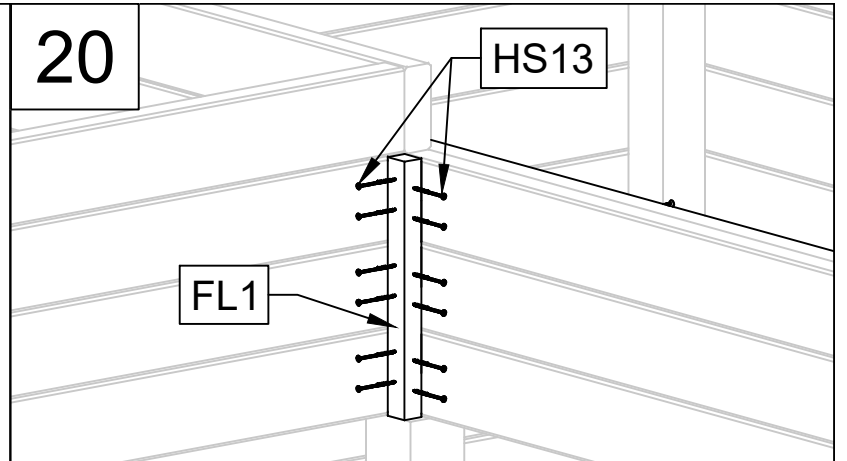
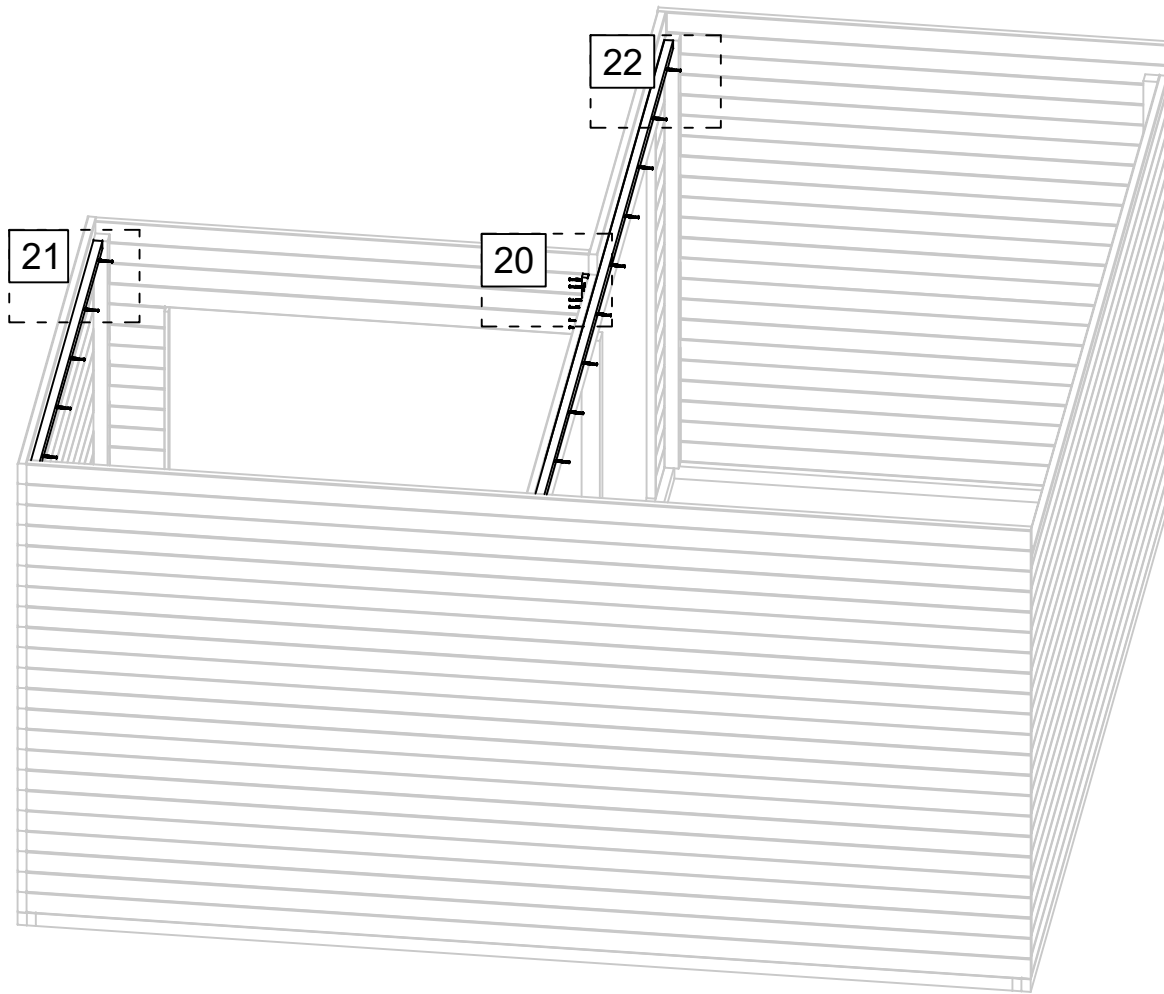

Art. Nr. 4424919

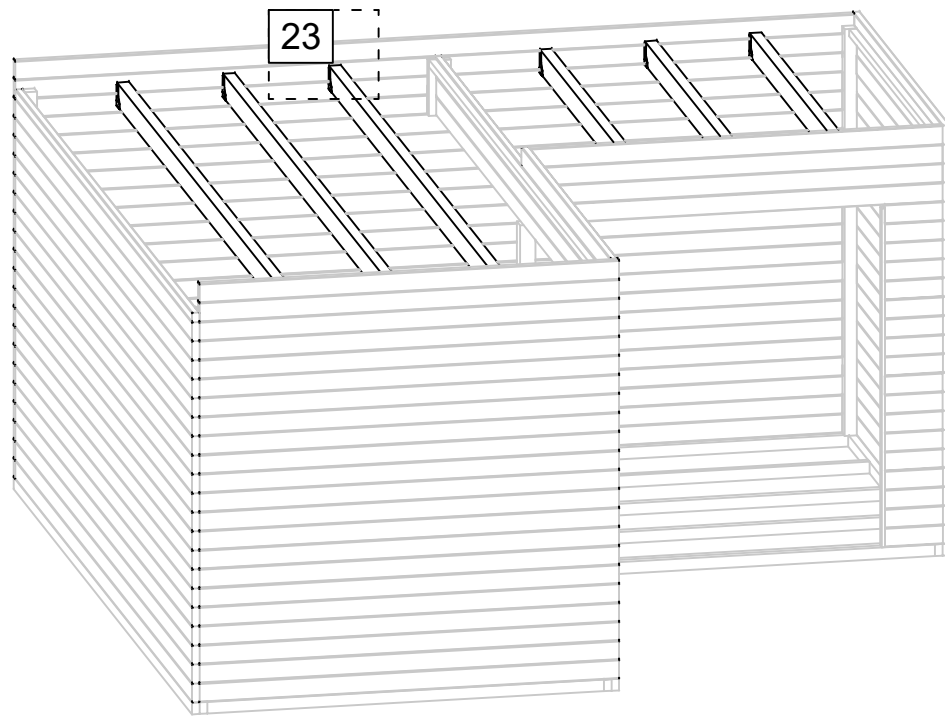

23

≈1,5cm

BM

HS12

HS12

BM

HS12

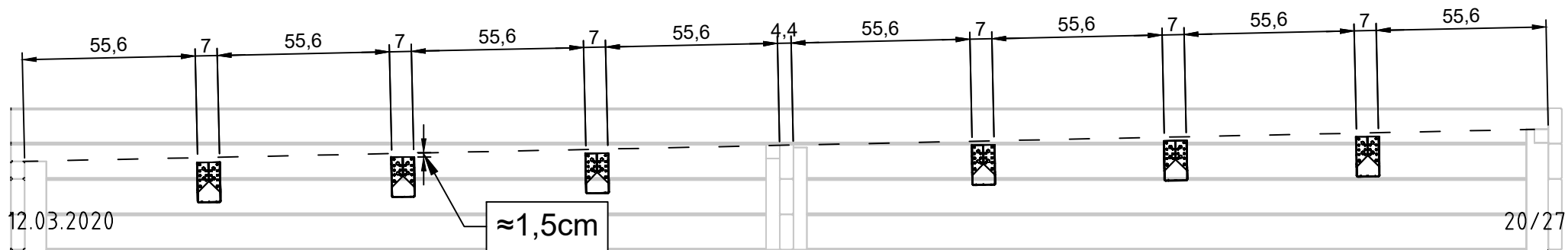

12.03.2020

≈1,5cm

20/27

Art. Nr. 4424919

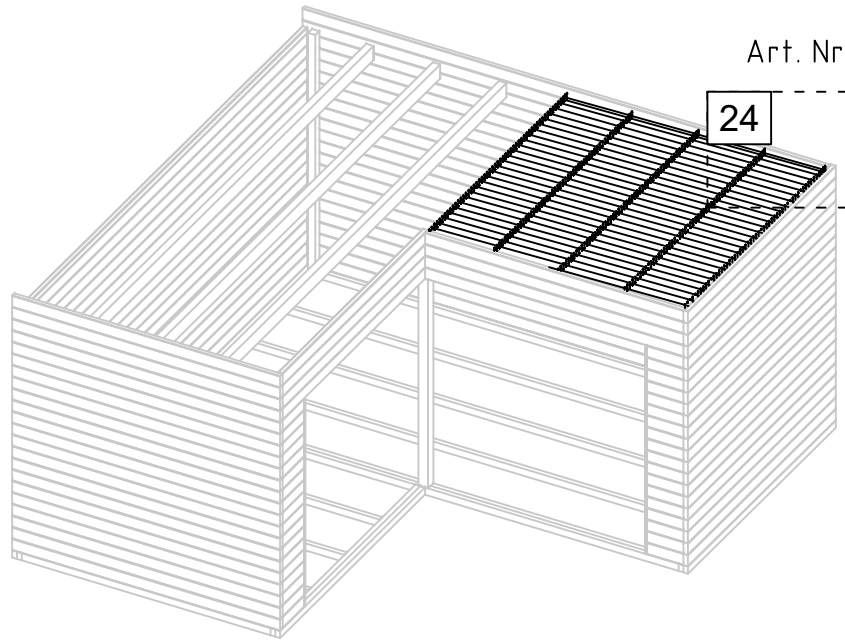

24

24

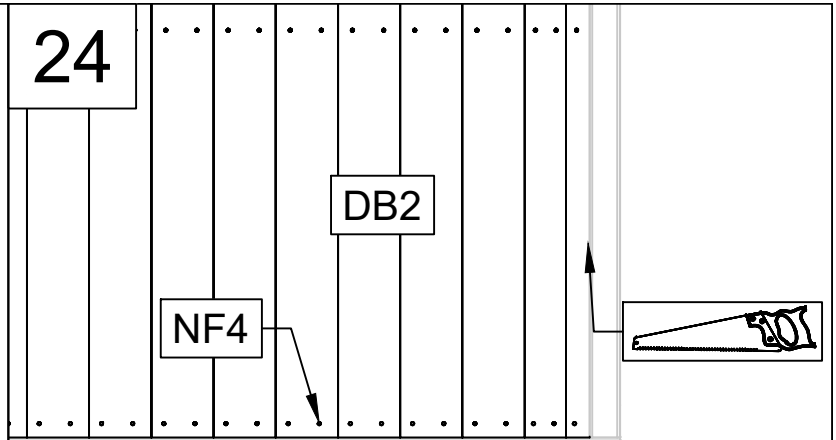

DB2

NF4

201

25

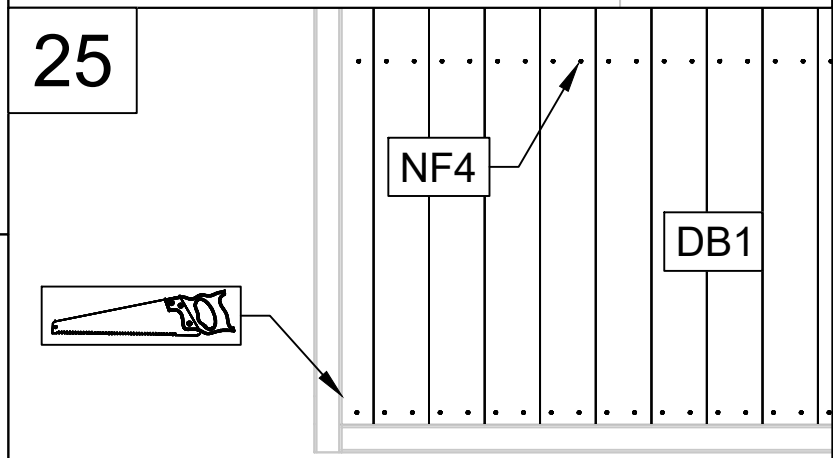

NF4

DB1

201

26

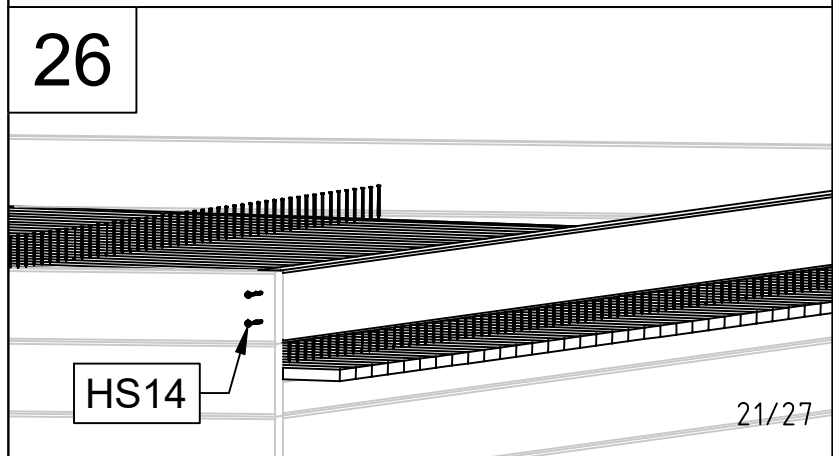

HS14

Art. Nr. 4424919

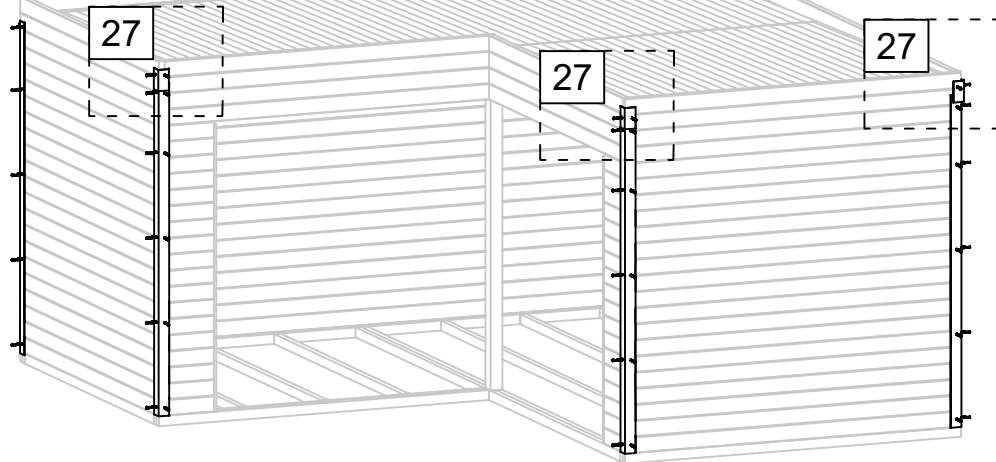

27

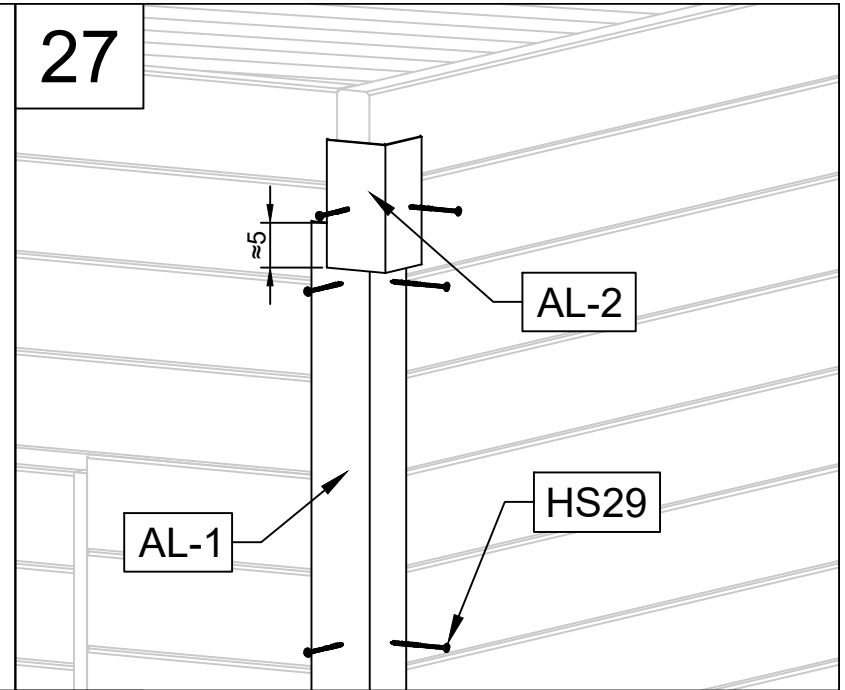

AL-1

AL-2

HS29

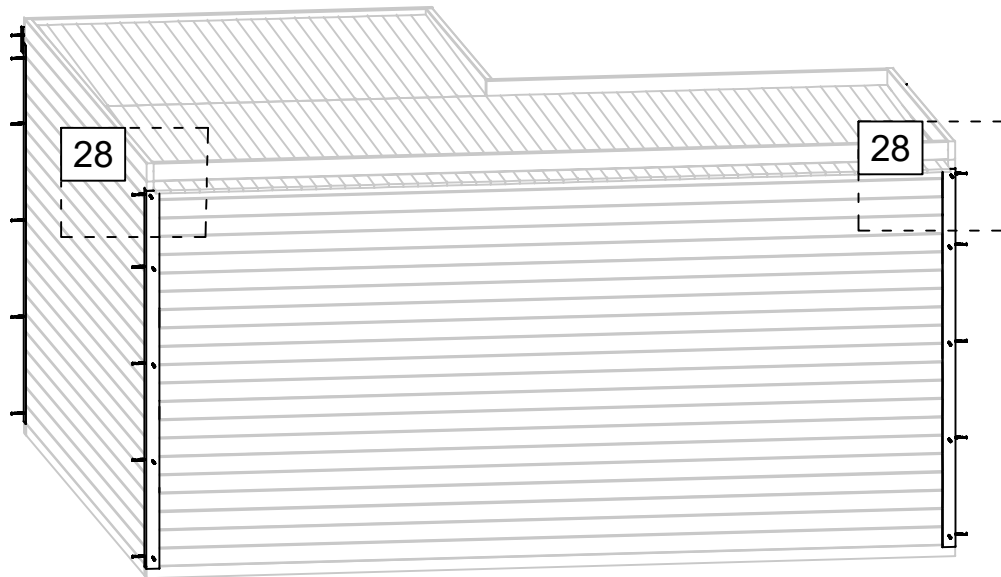

28

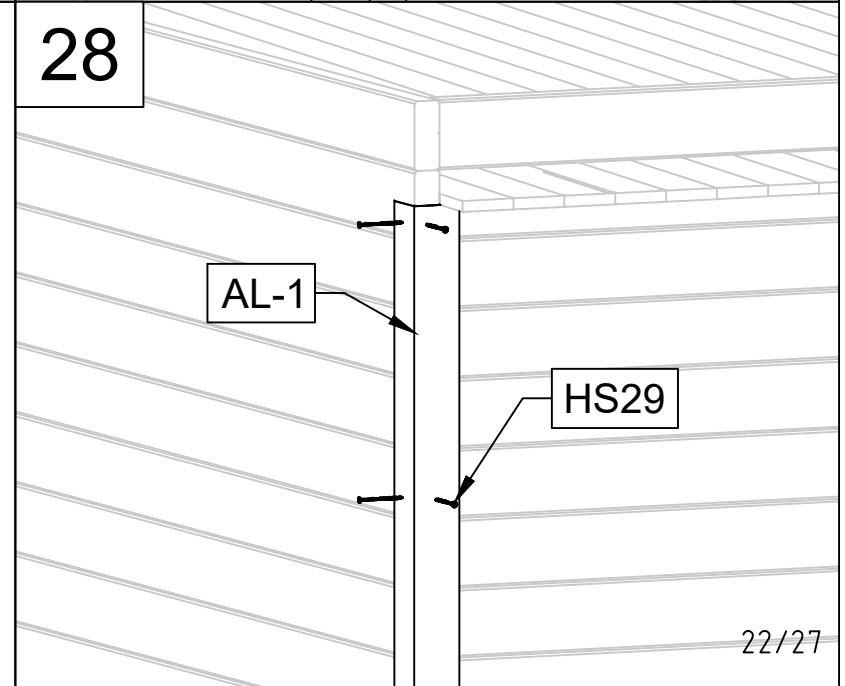

AL-1

HS29

Art. Nr. 4424919

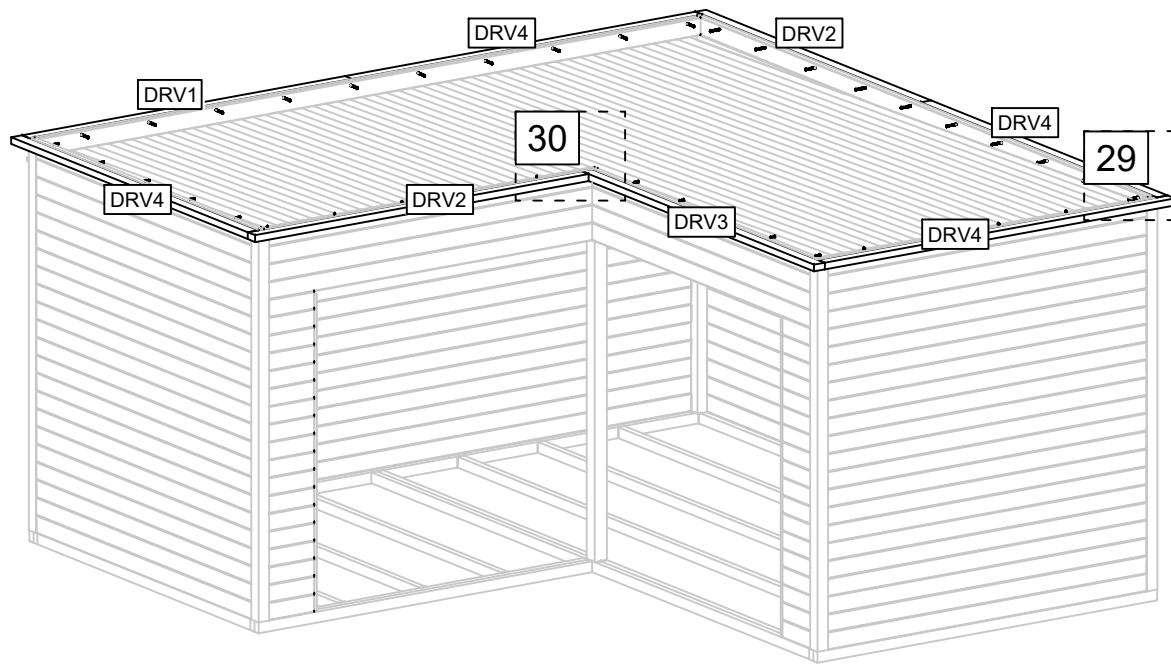

29

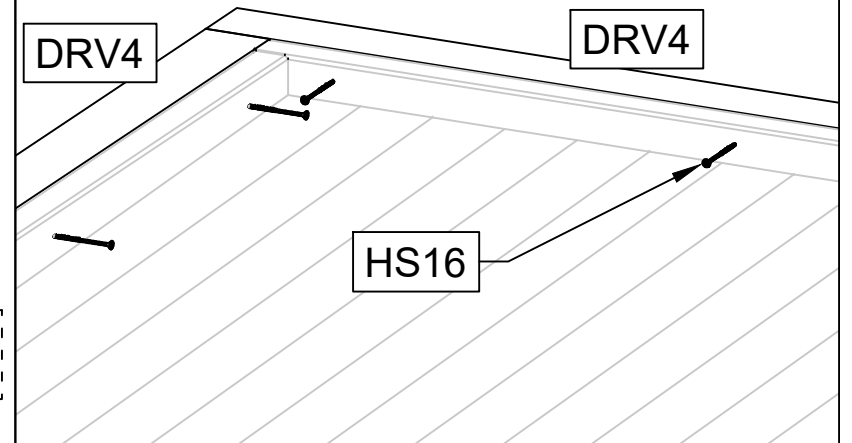

30

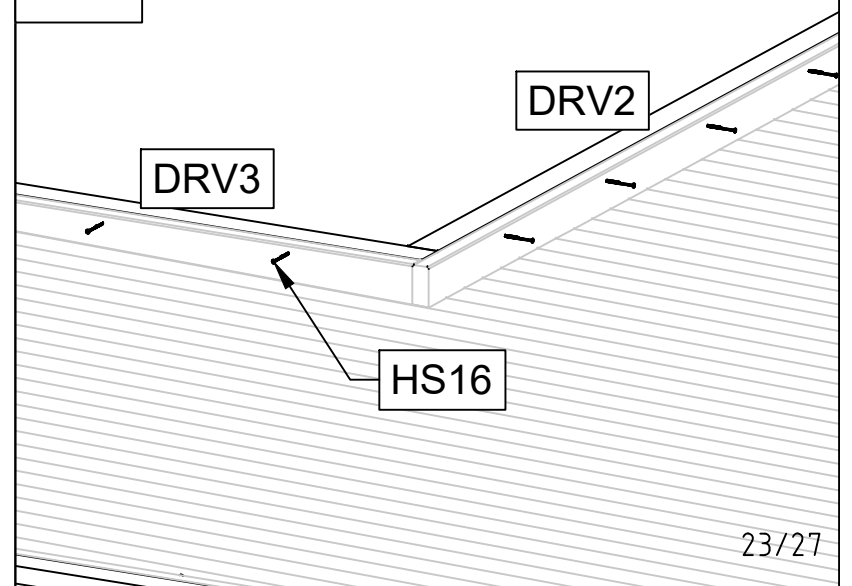

Art. Nr. 4424919

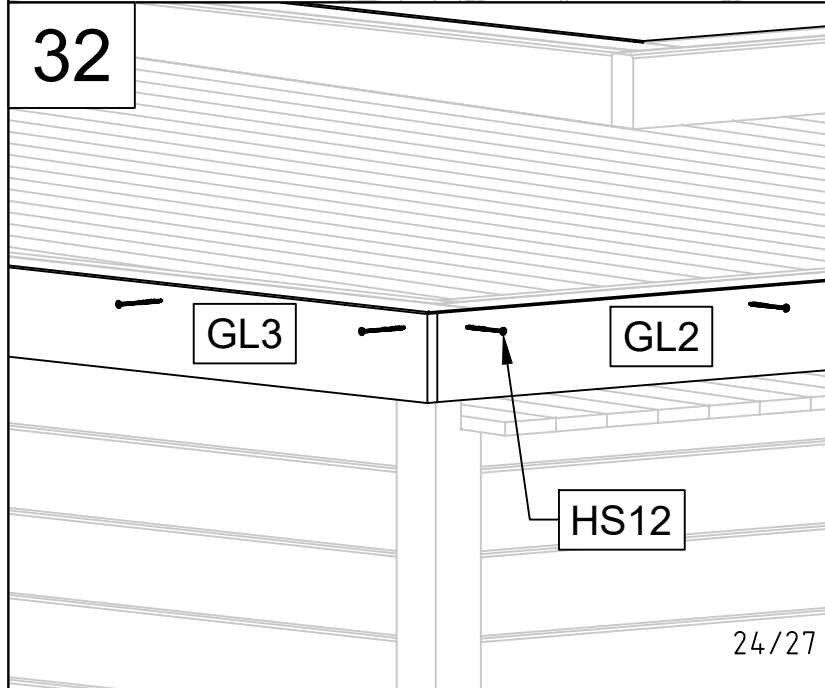
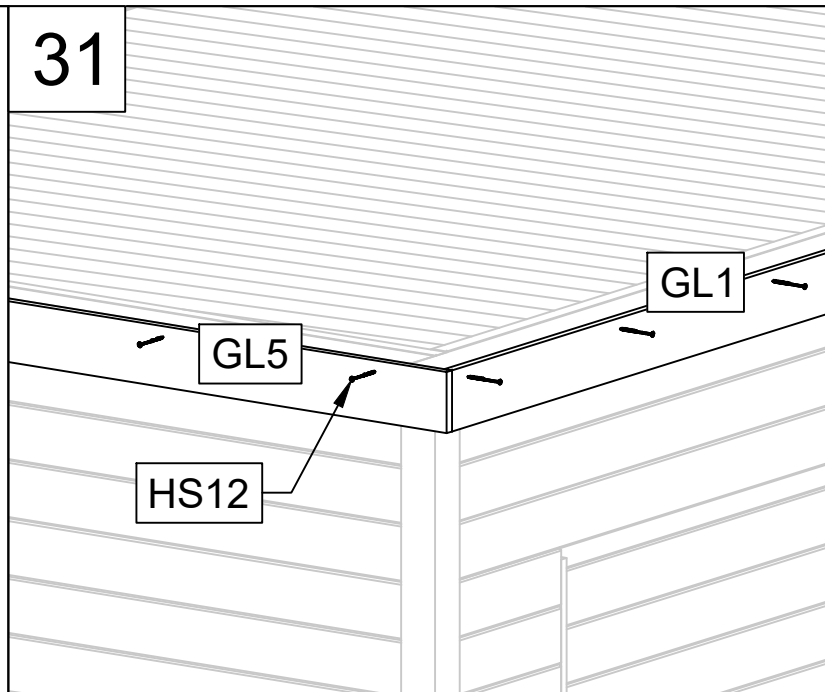
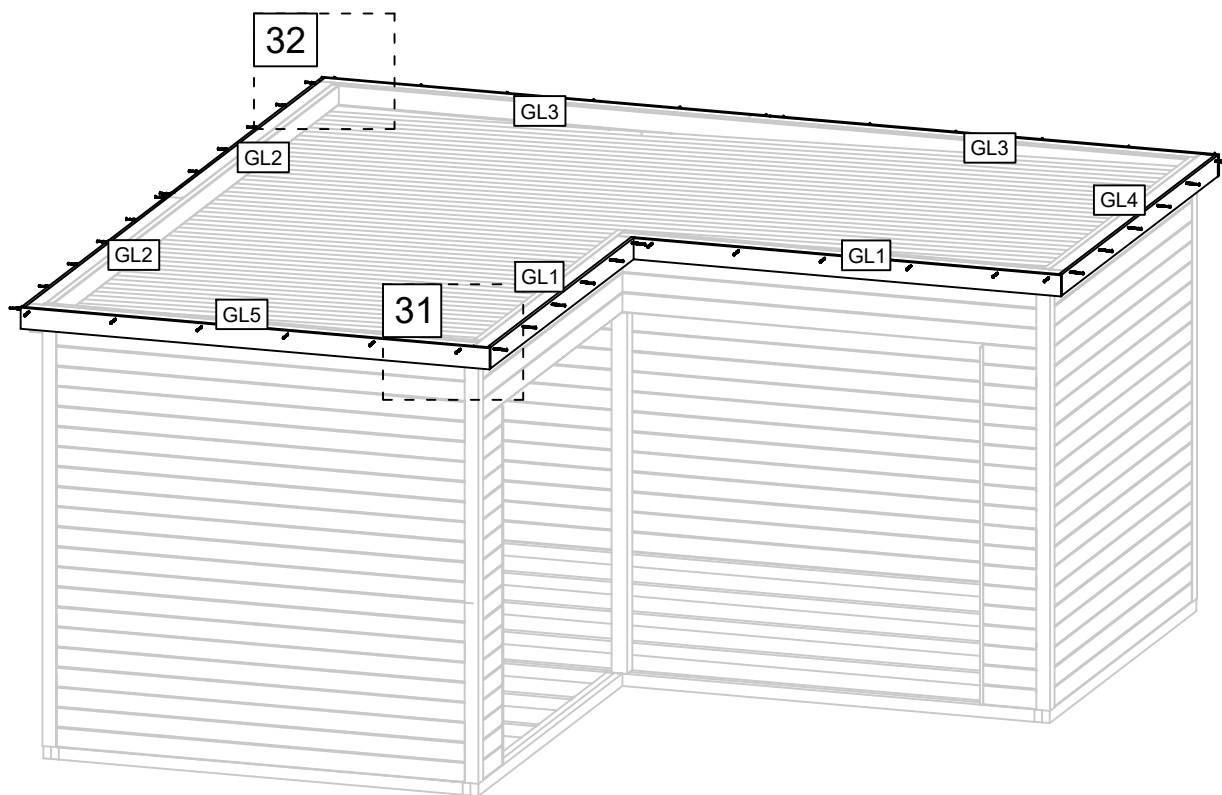

Art. Nr. 4424919

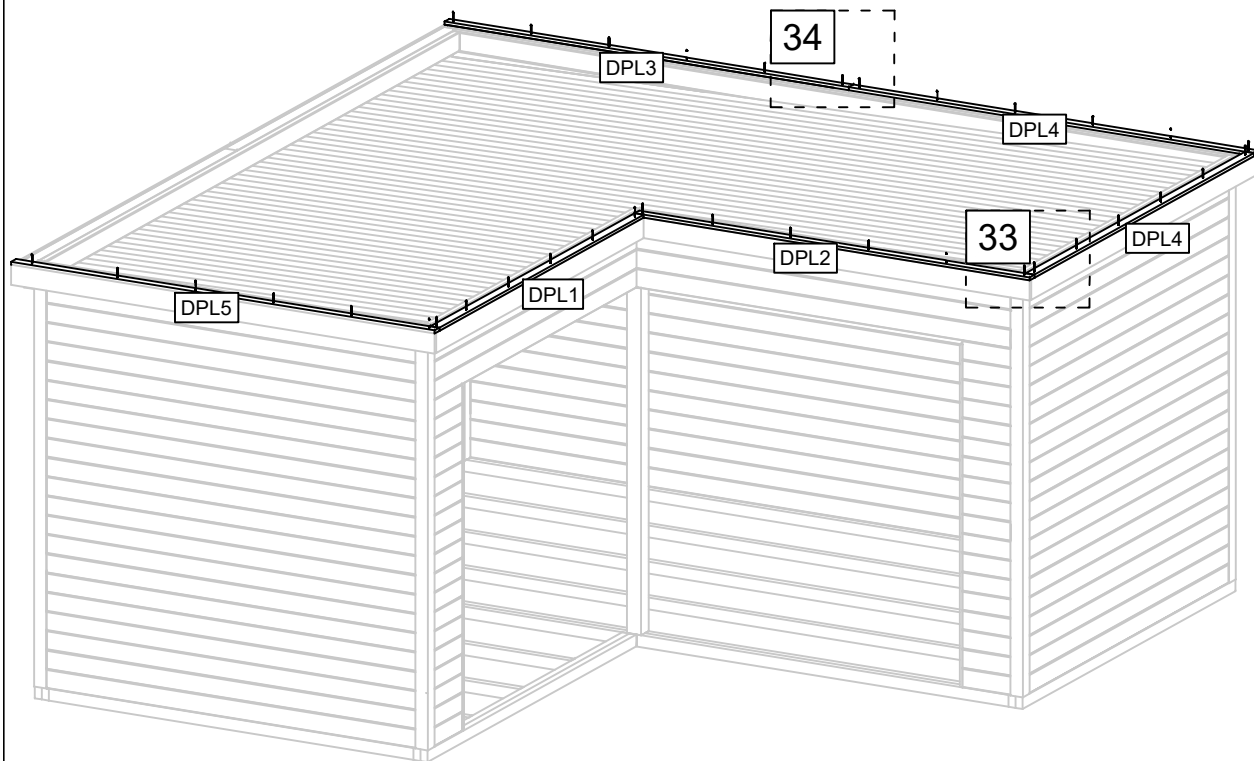

33

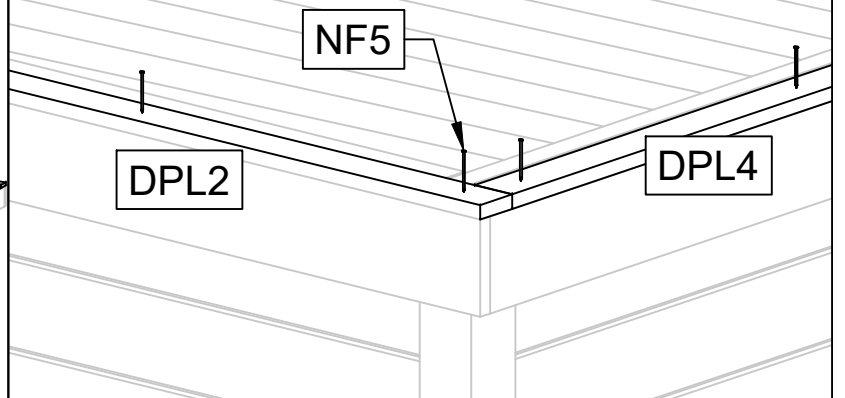

34

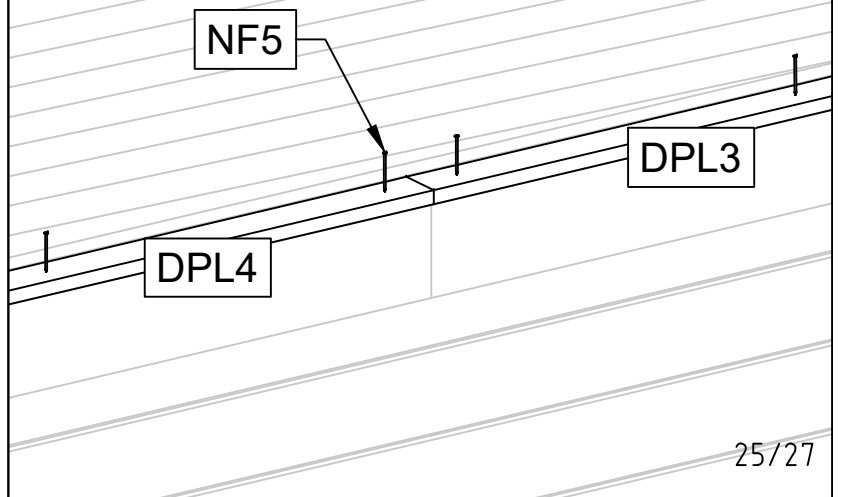

Art. Nr. 4424919

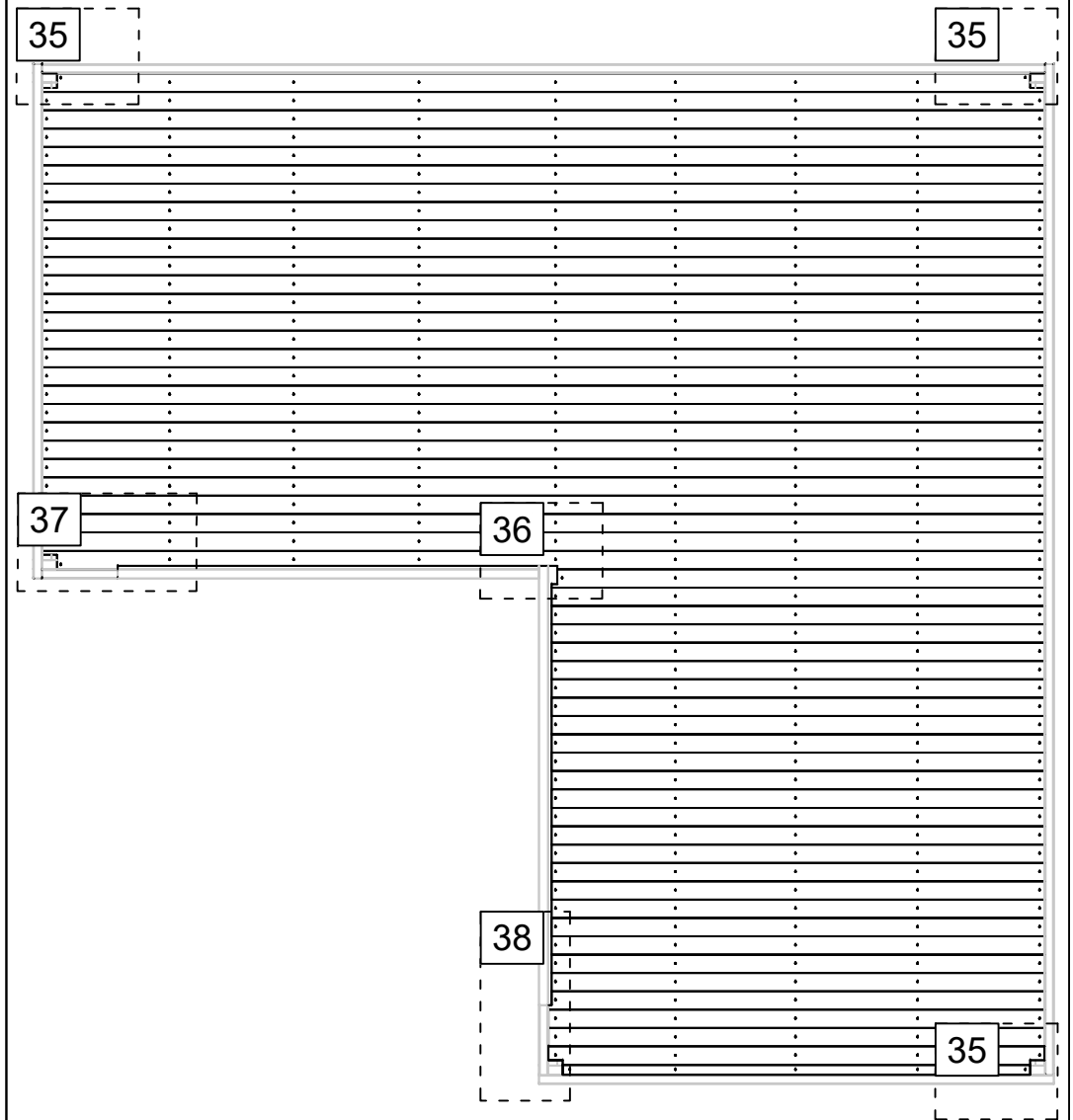
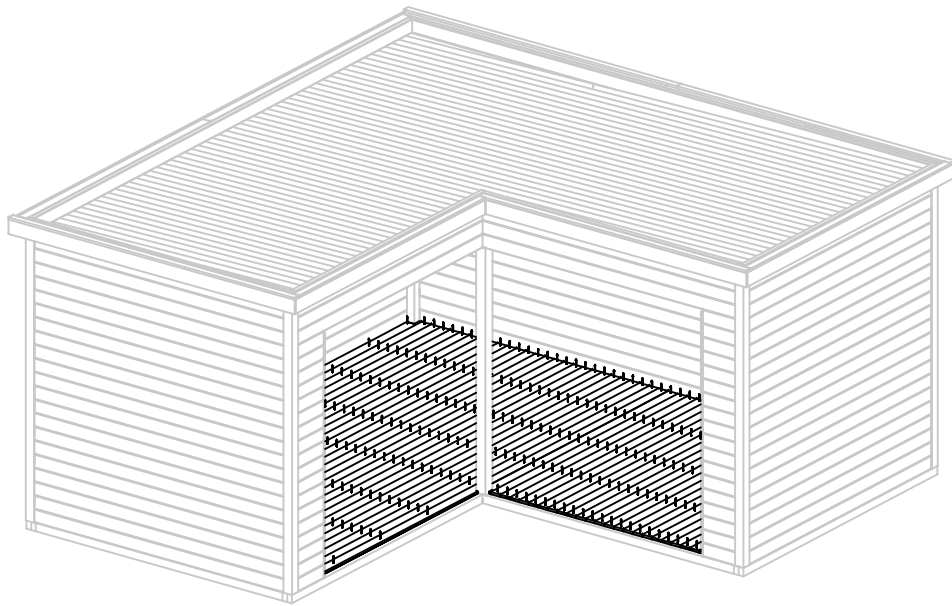

35

Art. Nr. 4424919

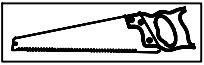
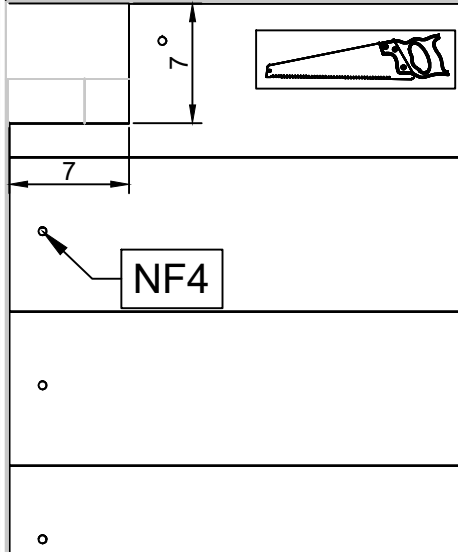

36

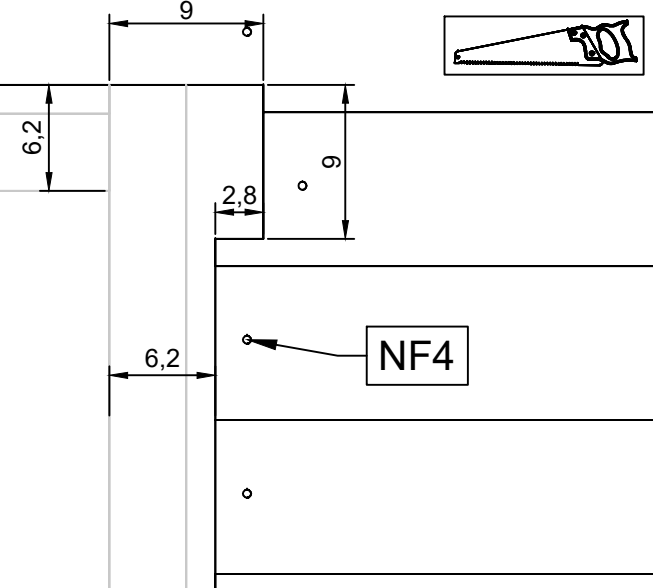

37

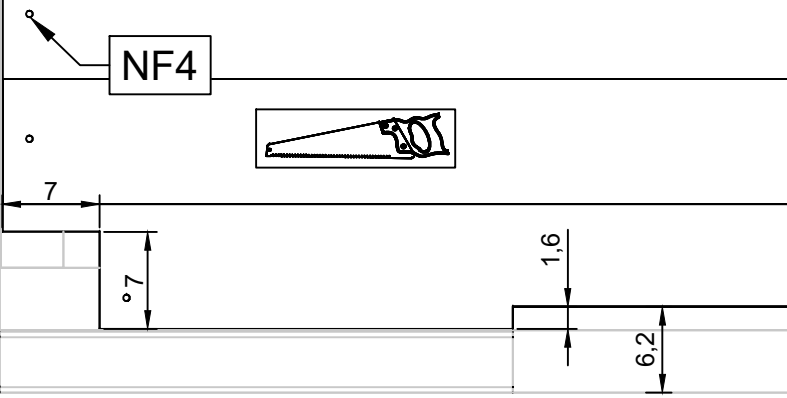

38

