

Art. Nr. 4018800

1/4

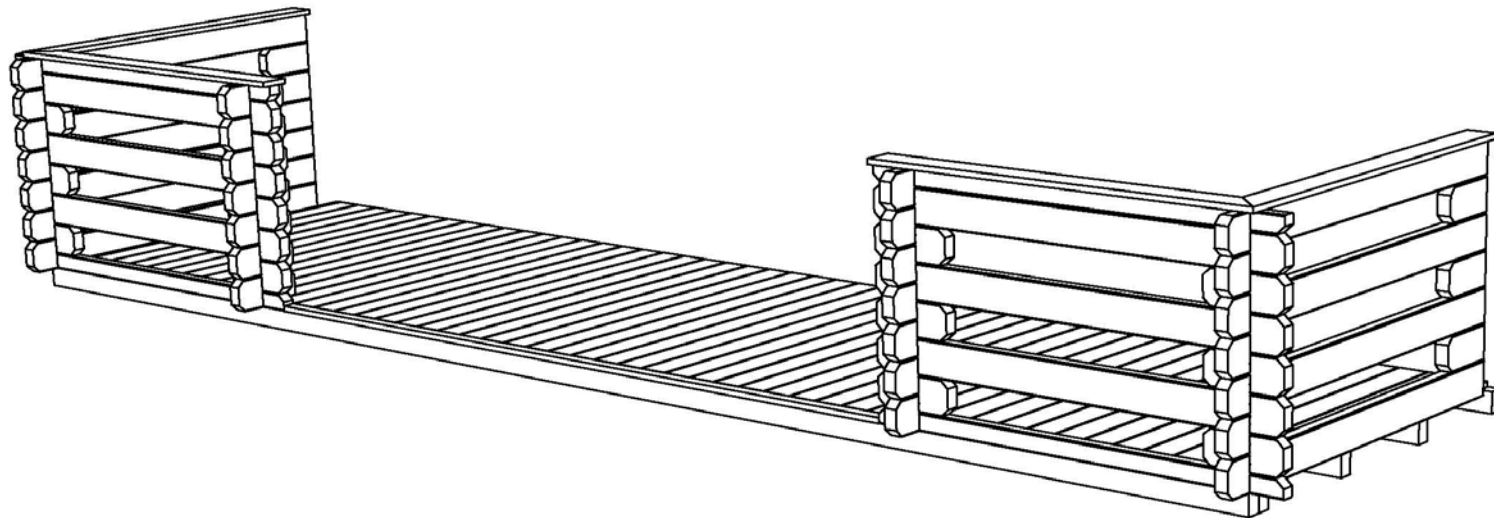

22.05.2018

Art. Nr. 4018800

Groundplan - Grundplan - Plan de masse - Planimetria -  
Plattegrond - Põhiplaan

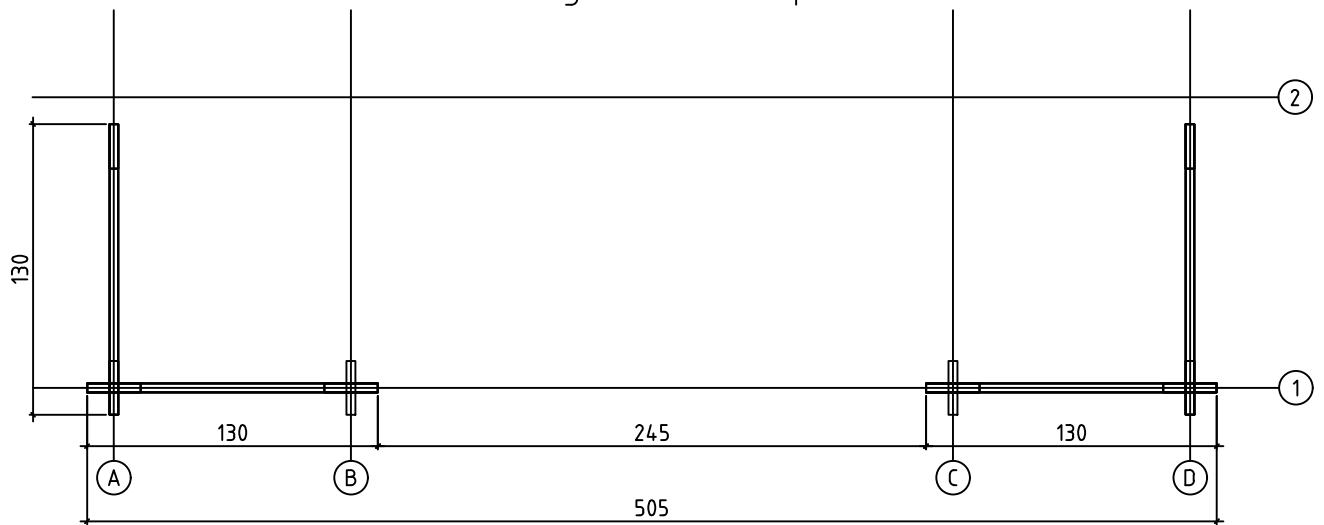

Foundation - Fundament - Fondation - Fondamenta -  
Fundering - Immutatud alusraam

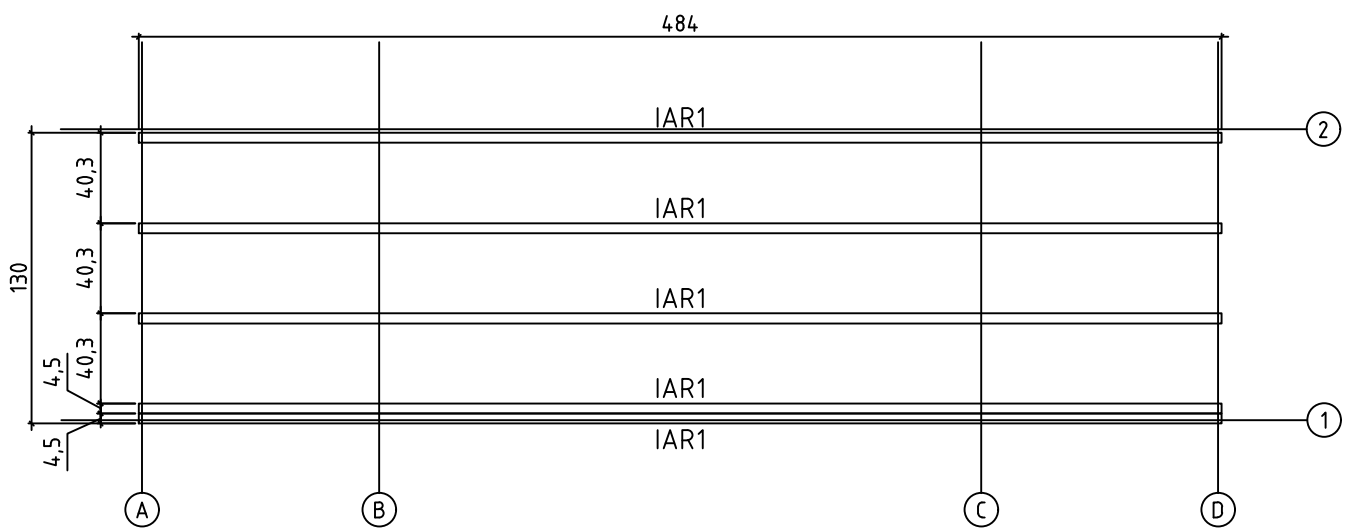



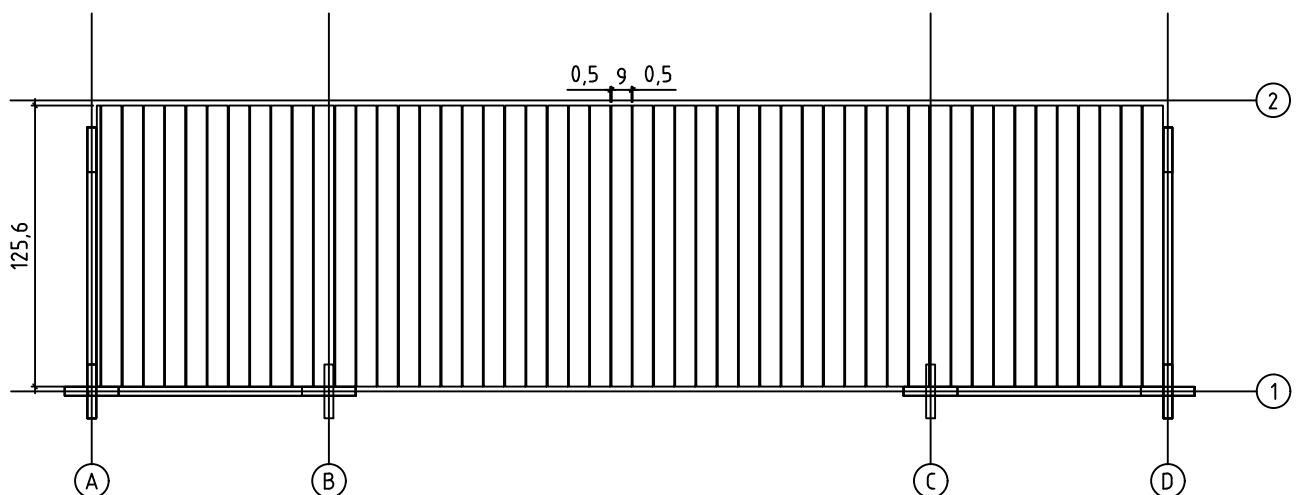



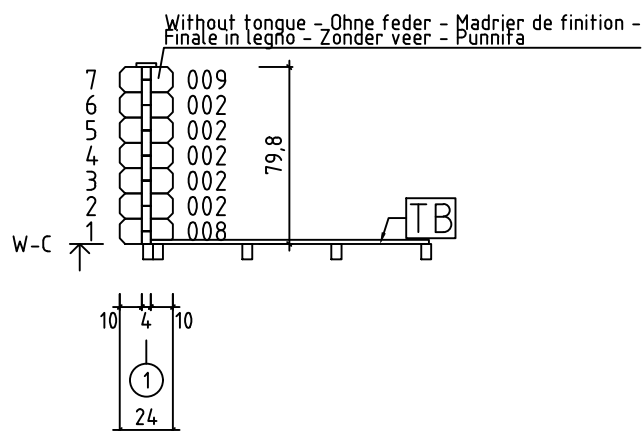
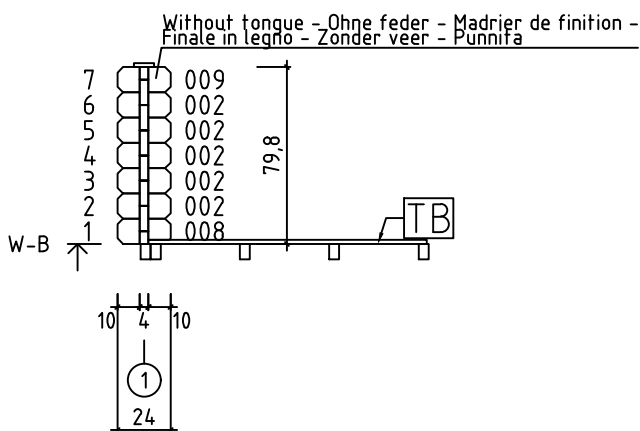
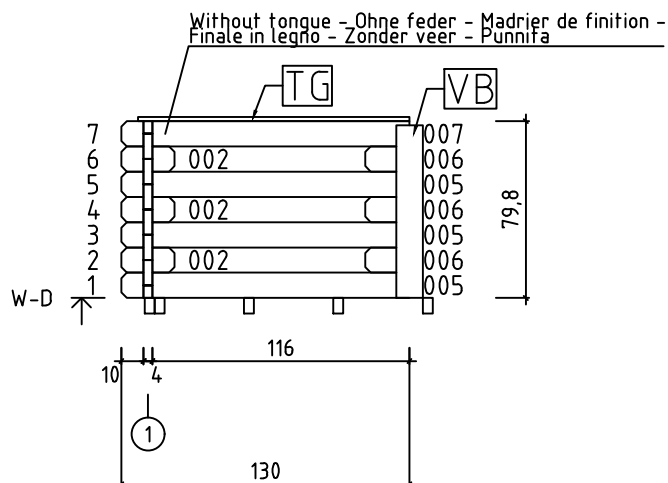
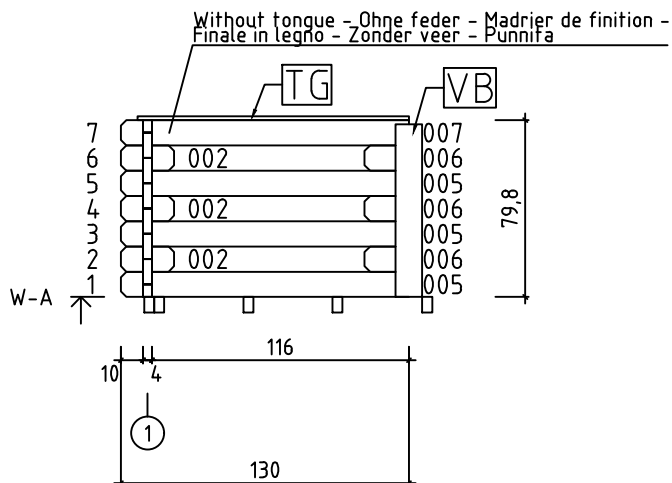
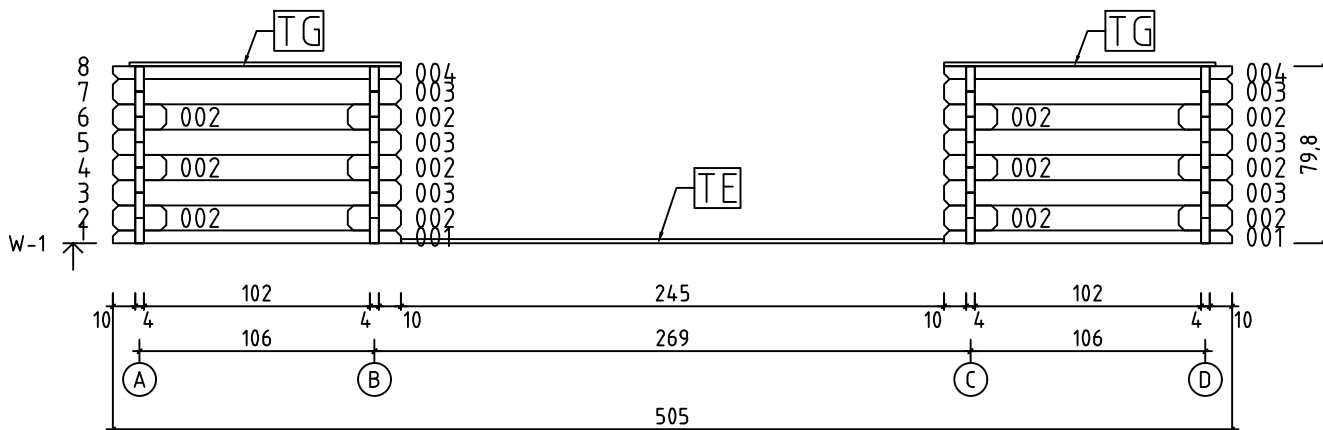

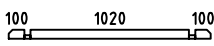

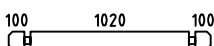
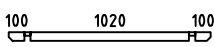
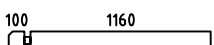

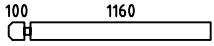



Terrace boards - Terrassenbretter - Plancher de terrasse -  
Piattaforme terrazzo - Terrasvloer - Terrassilaudis

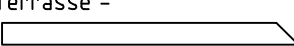

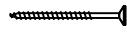
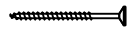
Art. Nr. 4018800

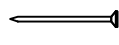

Pos	22.05.2018 Piece list - Stückliste - Liste des pièces - Elementi - Stuklijst - Tükítabel Art. Nr. 4018800 4/4	Q	P (mm)	L (mm)
001		2	40x57	1300
002	100100 	28	40x114	240
003		6	40x114	1300
004		2	40x53	1300
005		6	40x114	1300
006		6	40x114	200
007		2	40x110	1300
008	100100 	2	40x114	240
009	100100 	2	40x110	240
IAR1	Foundation - Fundament - Fondation - Fondamenta - Fundering - Immutatud alusraam 	5	45x70	4840
TB	Terrace boards - Terrassenbretter - Plancher de terrasse - Piattaforme terrazzo - Terrasvloer - Terrassilaud 	51	90x19	1256
TE	Terrace edge board - Terrassenbrett, eingang - Lamé de seuil d'entree de terrasse - Terrazzo uso abitacolo - Terrasvloer dorpel - Terrassi servaliist 	1	19x40	2448
TG	Guard-rail for terrace - Terrassengeländer - Main courante de terrasse - Guardrail per terrazzo - Terras leuning - Terrassi äärelaud 	4	18x90	1223
VB	Terrace joint boards - Verbindungsbrett - Profil de jonction pour fixer la terrasse au mur - Assi del terrazzo che compongono il pavimento - Terras verbindungsplank - Terrassi ühenduslaud 	4	18x120	779
HS9	Screw for terrace joint boards - Schrauben für Verbindungsbrett - Vis de fixation profil de jonction terrasse - Vite per unire delle assi del terrazzo - Schroef voor bevestigen verbindingshout - Kruvi terrassi ühenduseks seinaga 	20	3.5x50	
HS12	Screws for terrace edge board - Schrauben für Terrassenbrett - Vis de fixation de lamé de seuil d'entree de terrasse - Vite per unire delle assi del terrazzo - Schroeven voor terrashout - Kruvi terrassi servaliistule 	7	4x40	
HS12	Screw for terrace rear boards - Schrauben für Terrassenrand - Vis de fixation pour main courante de terrasse - Vite per il piano posteriore della terrazzo - Schroef voor terras afsluitplint (achterzijde) - Kruvi terrassi äärelauale 	16	4x40	
HS16	Screw for 1. wall beam - Schraube für 1. Bohlenreihe - Vis de fixations 1ere rangée de madriers avec poutrelles de fondations - Vite fissaggio alle fondamenta - Schroef voor 1 wandbalk - Kruvi poollauale 	8	5x90	
HS16	Screw for foundation - Schrauben zur Befestigung Fundament - Vis de fixations des poutrelles de fondations - Viti x fondamenta - Schroef voor fundering - Kruvi alusraamile 	3	5x90	
HS22	Screw for 1. wall beam - Schraube für 1. Bohlenreihe - Vis de fixations 1ere rangée de madriers avec poutrelles de fondations - Vite fissaggio alle fondamenta - Schroef voor 1 wandbalk - Kruvi poollauale 	4	6x150	
NF3	Zn nail for terrace - Zn Nägel für Terrassenbretter - Pointe pour plancher de terrasse - Chiodo zincato per terrazza - Spijker(nagel) voor terrasvloer - Nael terrassilauale 	408	2.1x50	