

Bike Extension 2600

Art. Nr. 2829600

1/8

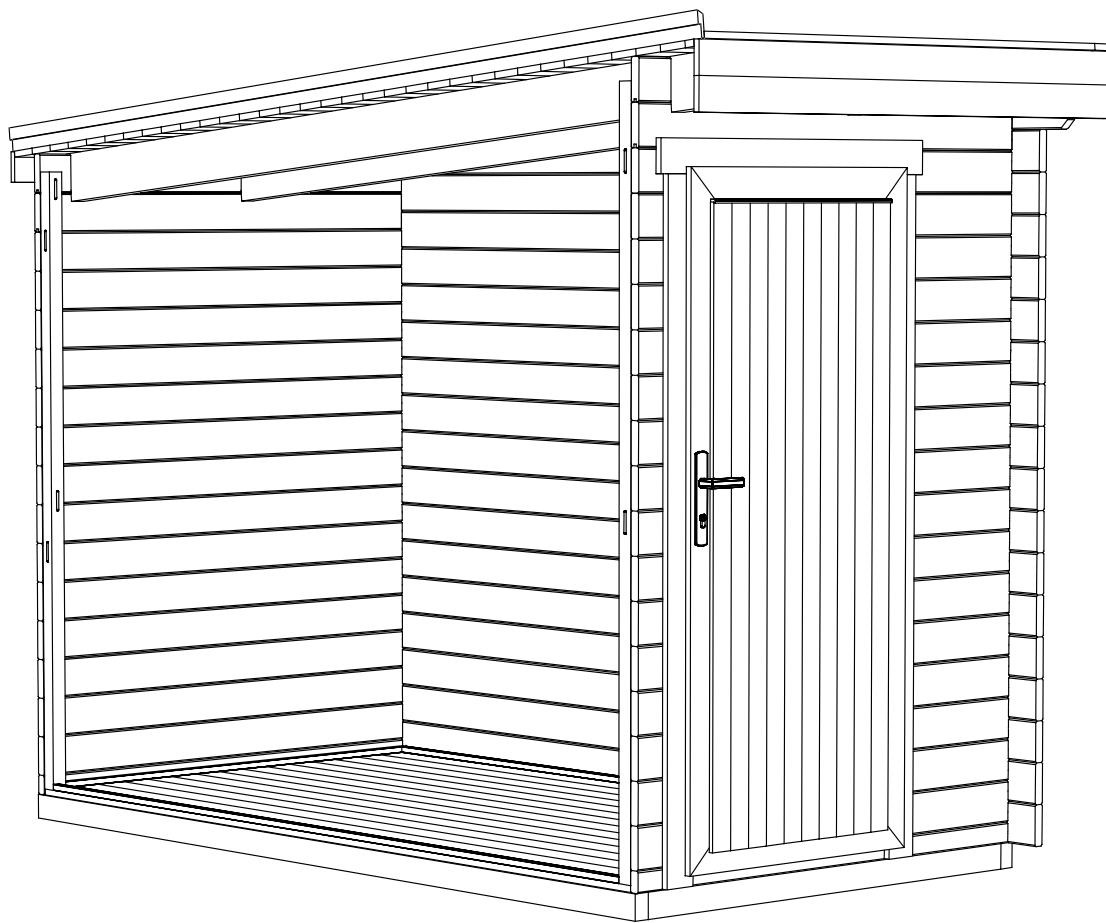

14.10.2016

GROUNDPLAN - GRUNDPLAN -
PLAN DE MASSE

Art. Nr. 2829600

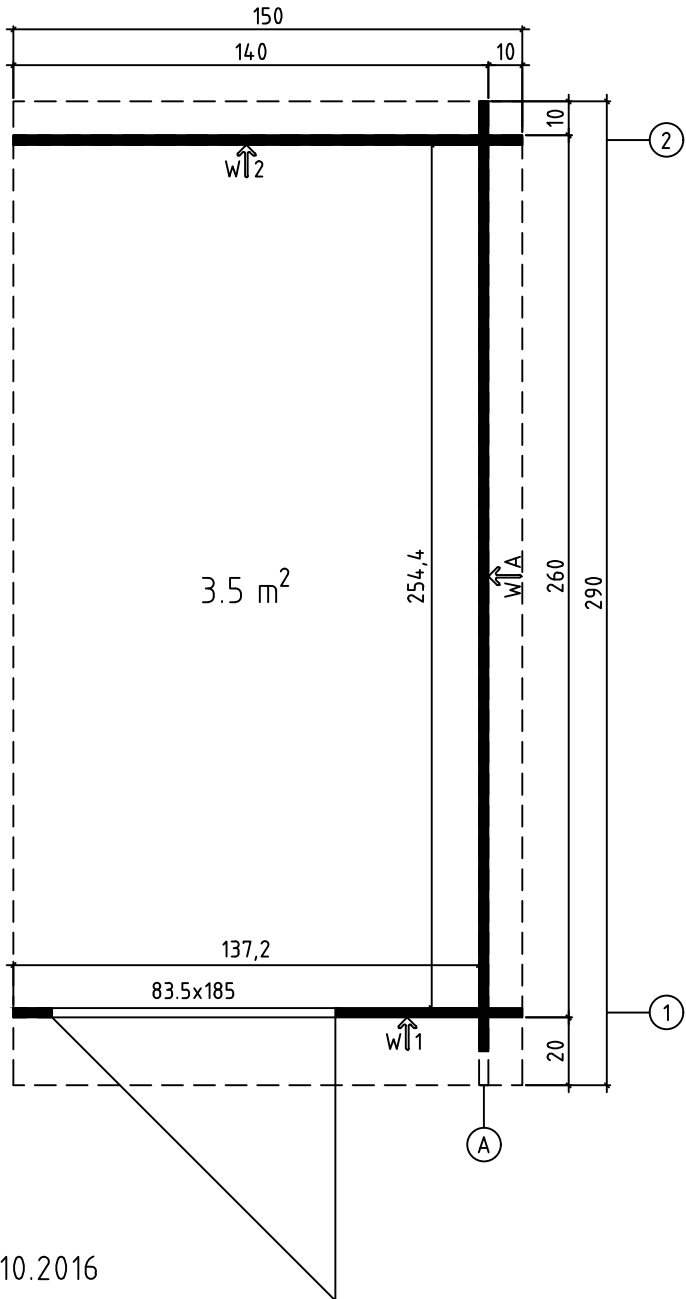

FOUNDATION - FUNDAMENT - FONDATION

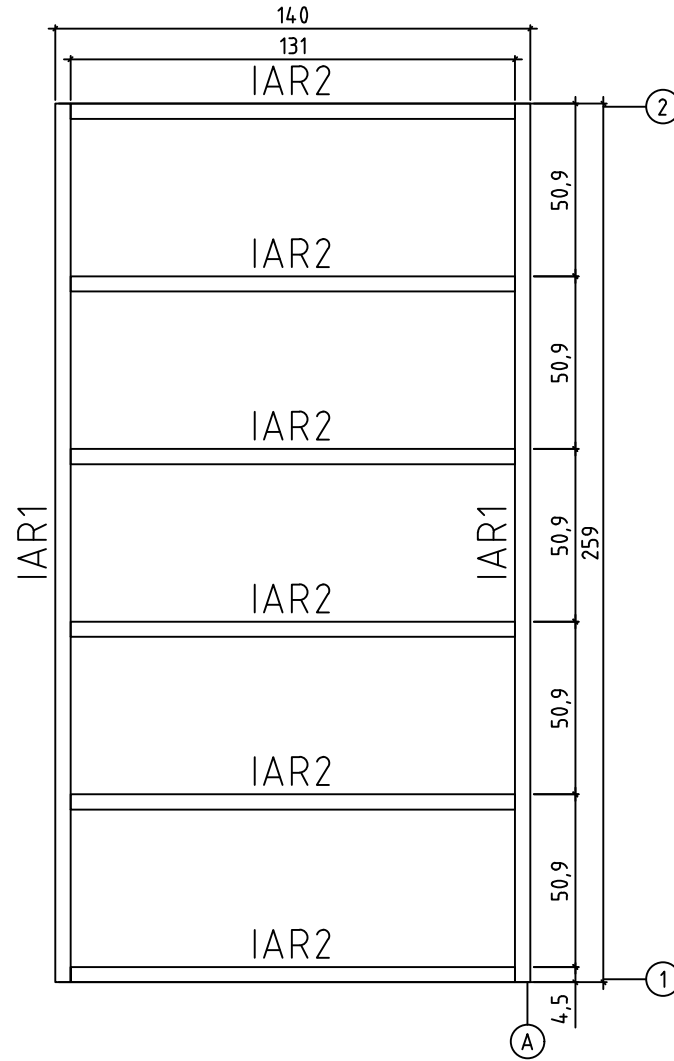

FLOOR BOARDS - FUSSBODENBRETTER -
PLAN POSE PLANCHER

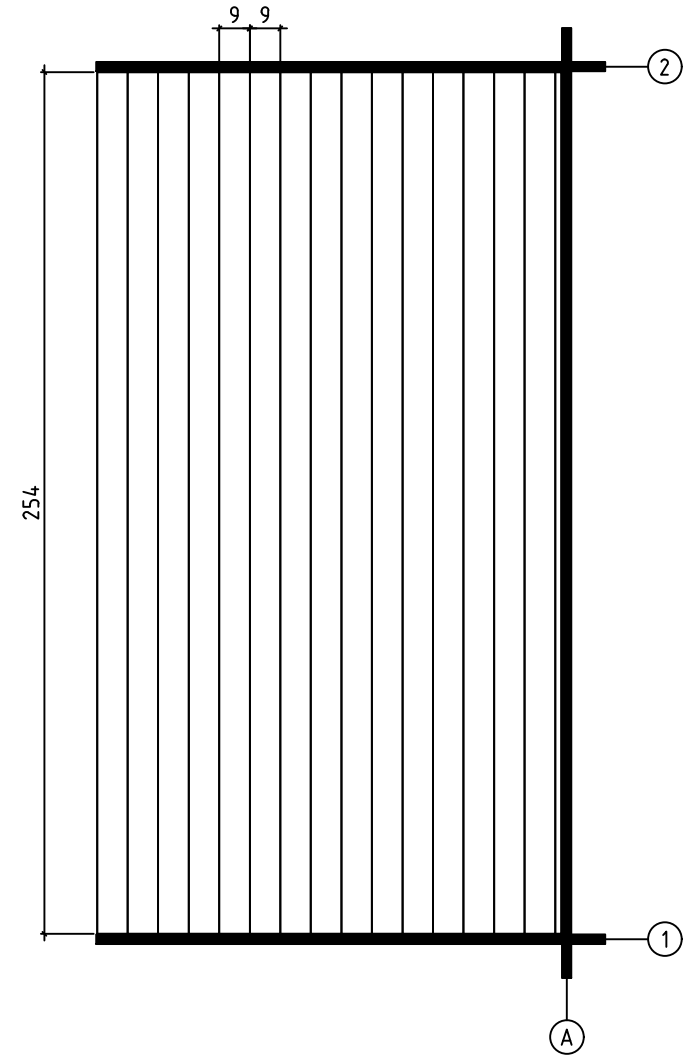



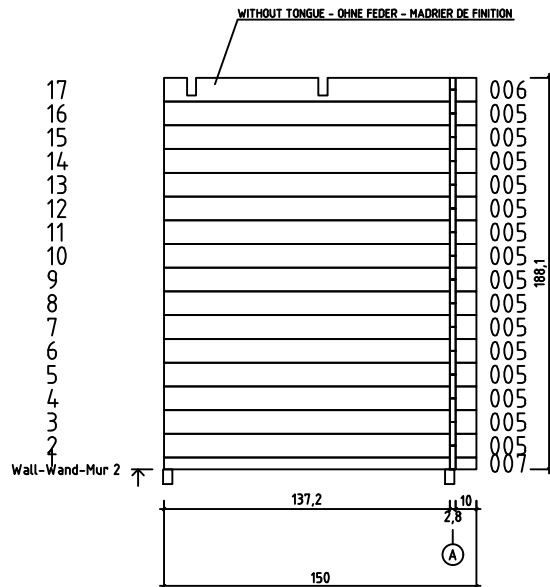
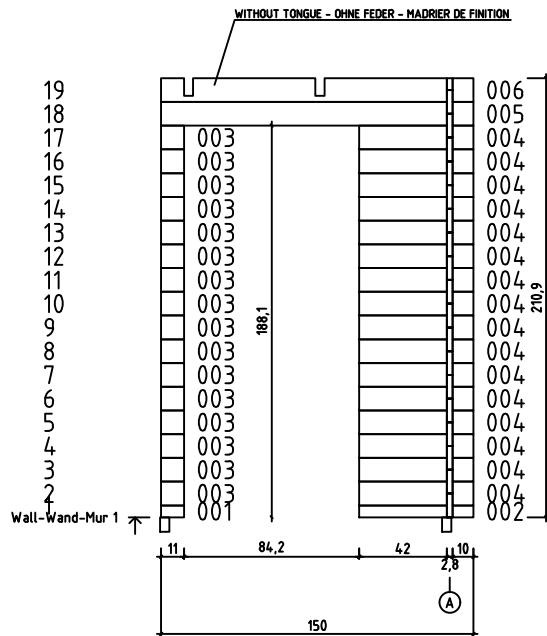
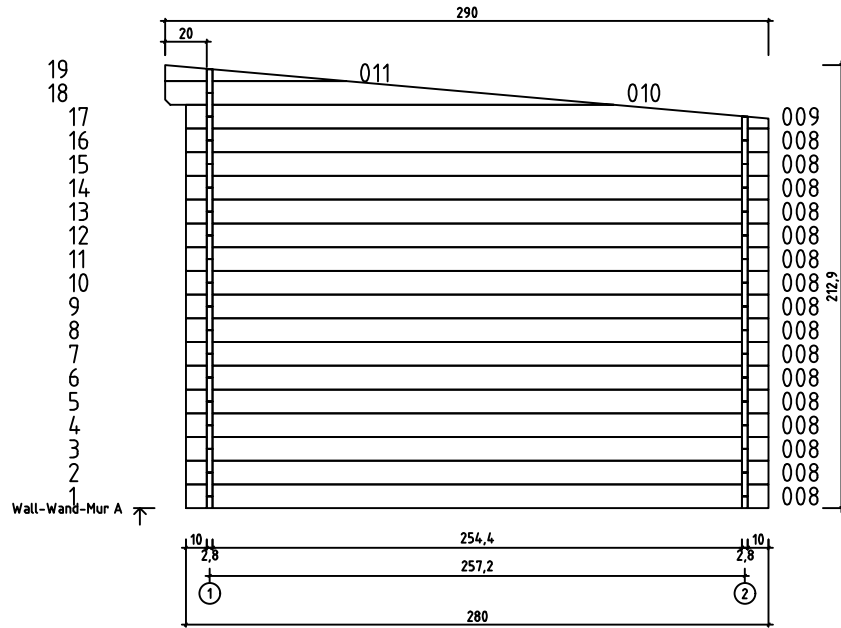

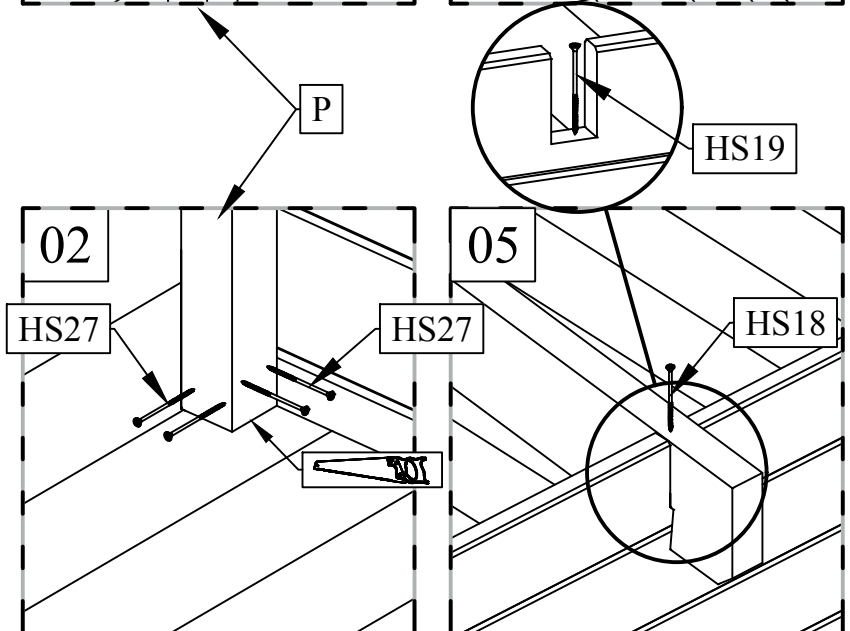
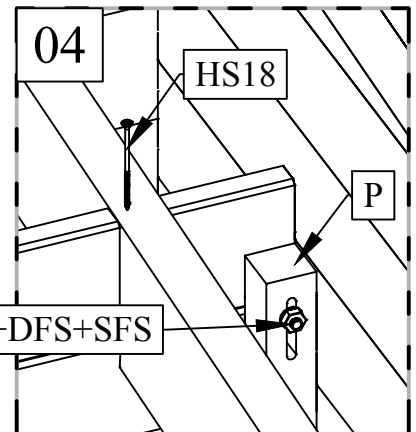
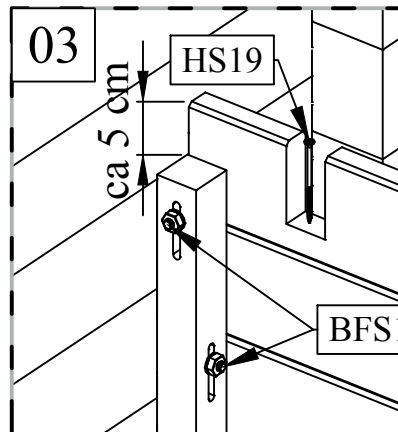
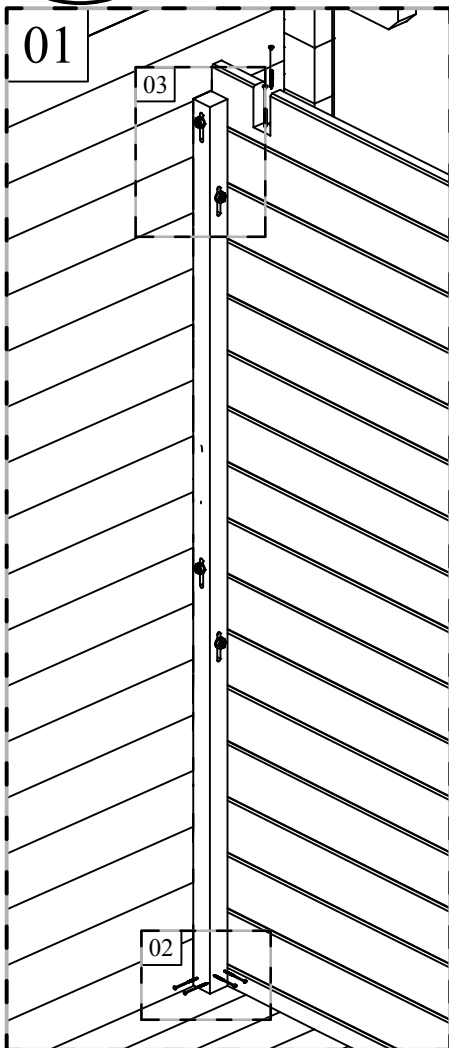
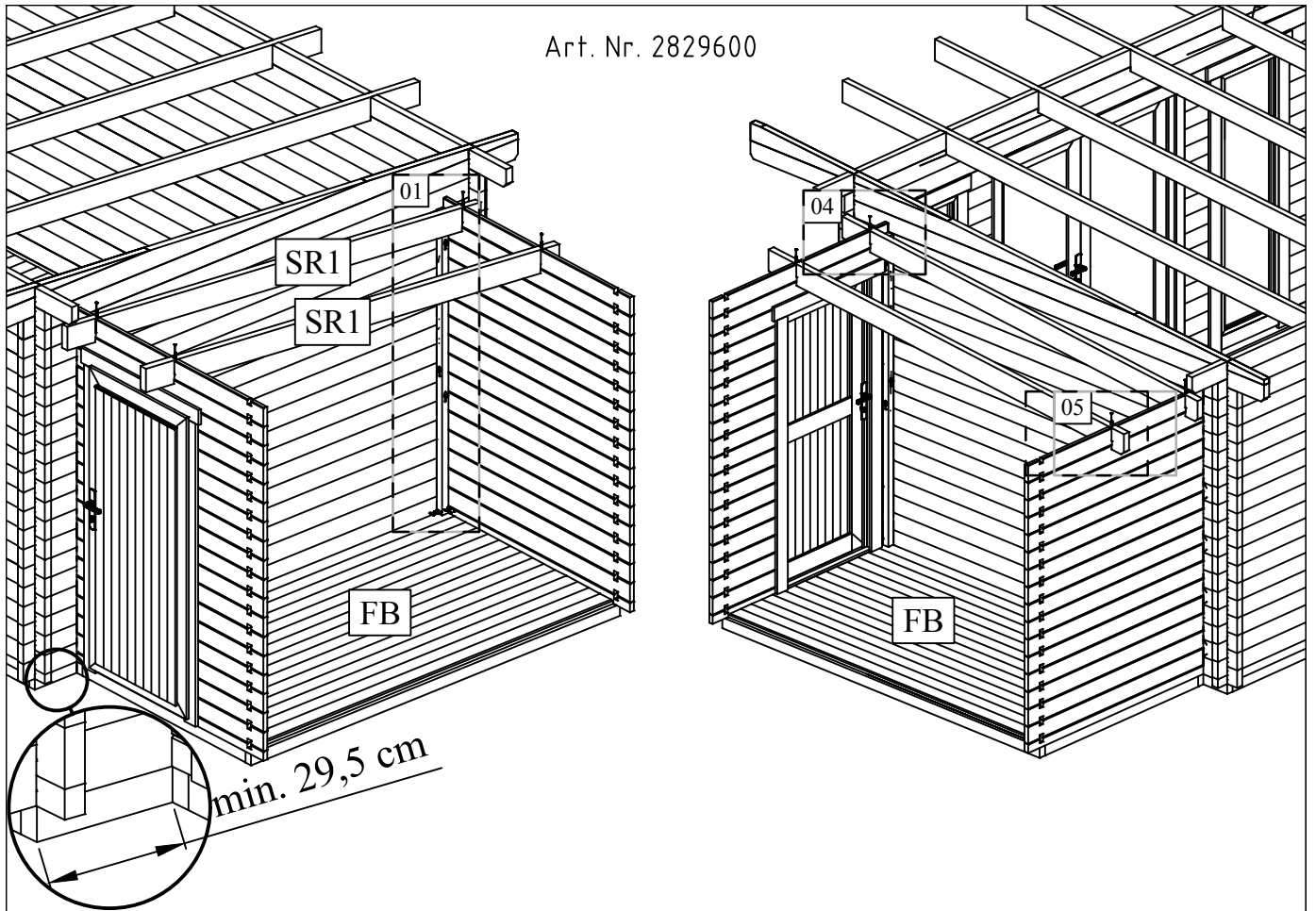

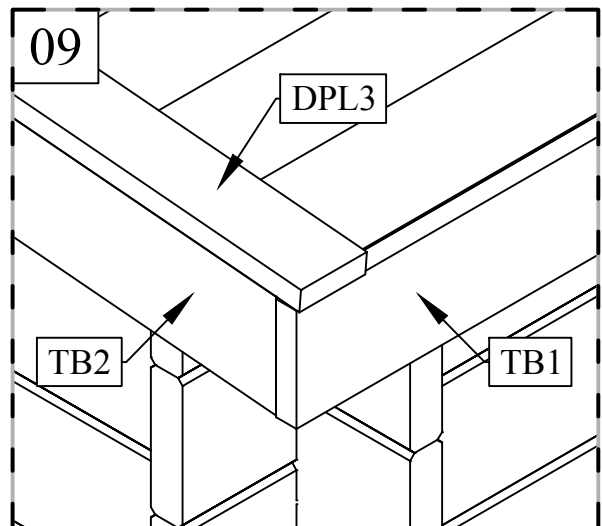
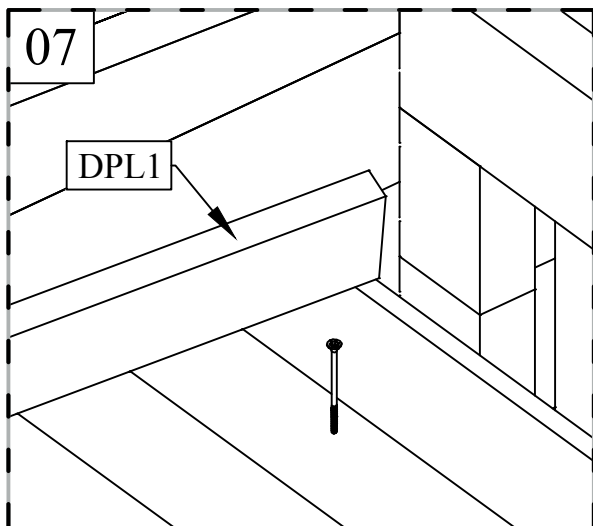
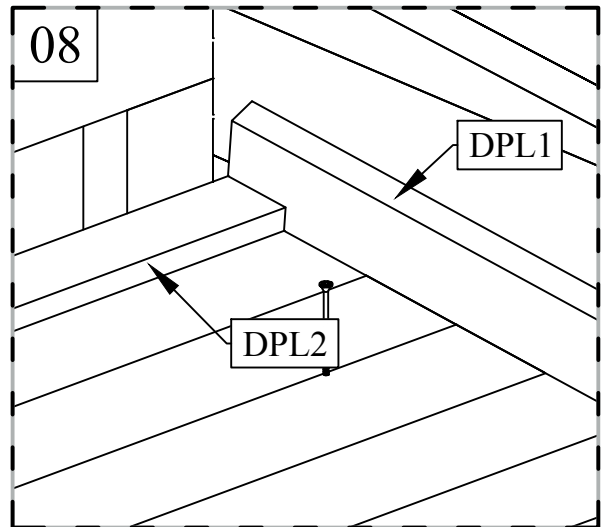
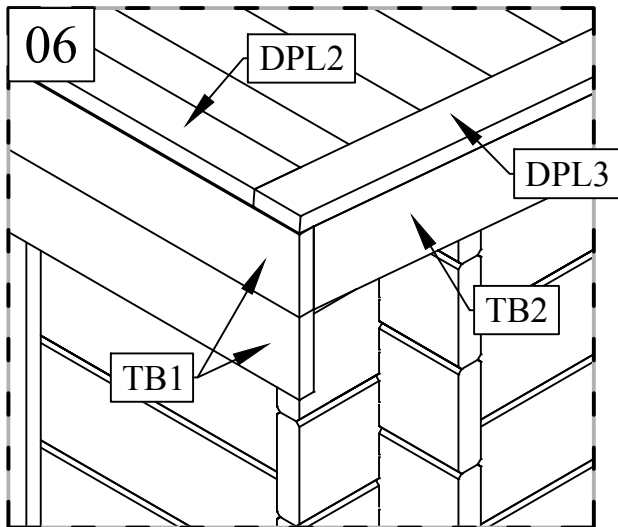
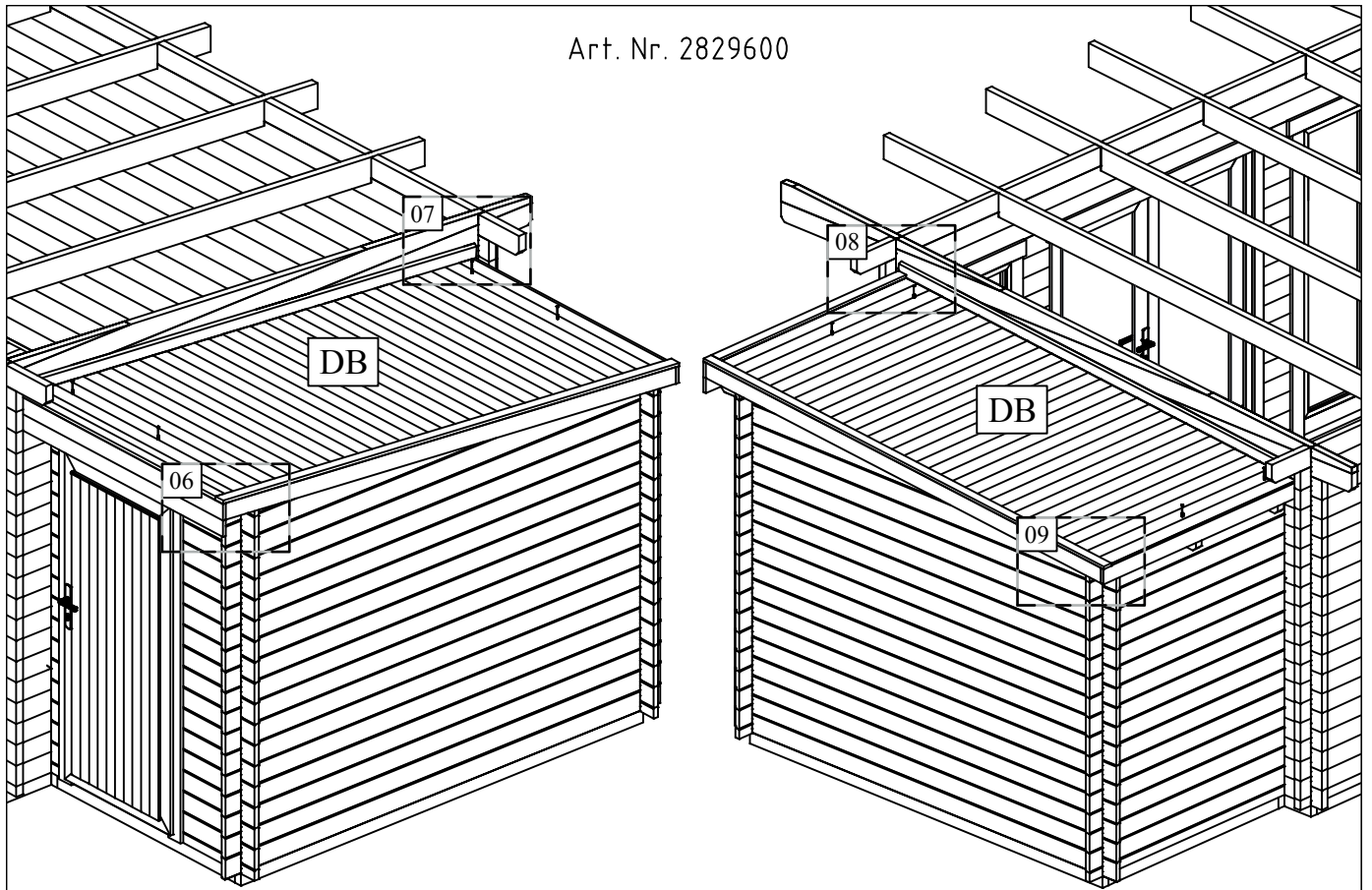





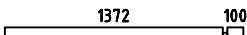
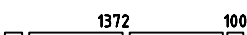
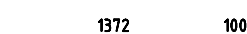
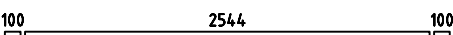
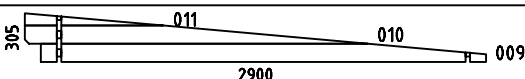

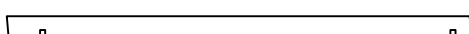

Art. Nr. 2829600



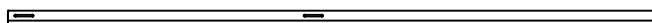
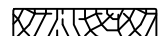
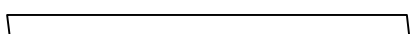

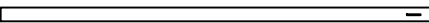

Pos	14.10.2016	Piece list - Stückliste - Liste des pièces Art. Nr. 2829600	6/8	Q	P (mm)	L (mm)
001				1	28x57	110
002				1	28x57	548
003				16	28x114	110
004				16	28x114	548
005				16	28x114	1500
006				2	28x114	1500
007				1	28x57	1500
008				16	28x114	2800
WA-1				1		
IAR1		FOUNDATION - FUNDAMENT - FONDATION		2	45x70	2590
IAR2		FOUNDATION - FUNDAMENT - FONDATION		6	45x70	1310
SR1		RAFTER - DACHSPARREN - CHEVRON		2	44x140	2923
FB	FLOOR BOARDS - FUSSBODENBRETTER - LAME DE PLANCHER			16	90x18	2540
DB	ROOF BOARDS - DACHBRETTER - VOLIGES			33	90x18	1500
FL	FLOOR FILLET - FUSSBODENLEISTE - CORNIERE DE FINITION DU PLANCHER				18x18	7.82
DPL1	ROOFING FELT FILLET - DACHPAPPENLEISTE - BAGUETTE DE FIXATION DU FEUTRE BITUMEUX			1	18x70	2950
DPL2	ROOFING FELT FILLET - DACHPAPPENLEISTE - BAGUETTE DE FIXATION DU FEUTRE BITUMEUX			1	18x58	1442
DPL3	ROOFING FELT FILLET - DACHPAPPENLEISTE - BAGUETTE DE FIXATION DU FEUTRE BITUMEUX			1	18x58	2950
P	STORM PROTECTION - STURMLEISTE - LATTE ANTI-TEMPETE			2	44x44	2030
TB1	FASCIA BOARD - TRAUFBRETT - BANDEAU DE TOIT			3	18x90	1518
TB2	FASCIA BOARD - TRAUFBRETT - BANDEAU DE TOIT			1	18x90	2920
DRV	ROOF EDGE REINFORCEMENT - DACHRANDVERSTÄRKUNG - CORNIERE DE RENFORT DE BORD DE TOIT			1	28x34	2550
KFS	STORM PROTECTION - STURMLEISTE - LATTE ANTI-TEMPETE			2	22x45	2050
HS9	SCREW FOR FASCIA BOARDS - SCHRAUBEN FÜR TRAUFBRETTER - VIS POUR FIXATION BANDEAU DE TOIT			34	3.5x50	
HS12	SCREW FOR ROOF EDGE REINFORCEMENT - SCHRAUBEN FÜR DACHRAND-VERSTÄRKUNG - VIS POUR FIXATION CORNIERE RENFORT DE BORD DE TOIT			6	4x40	

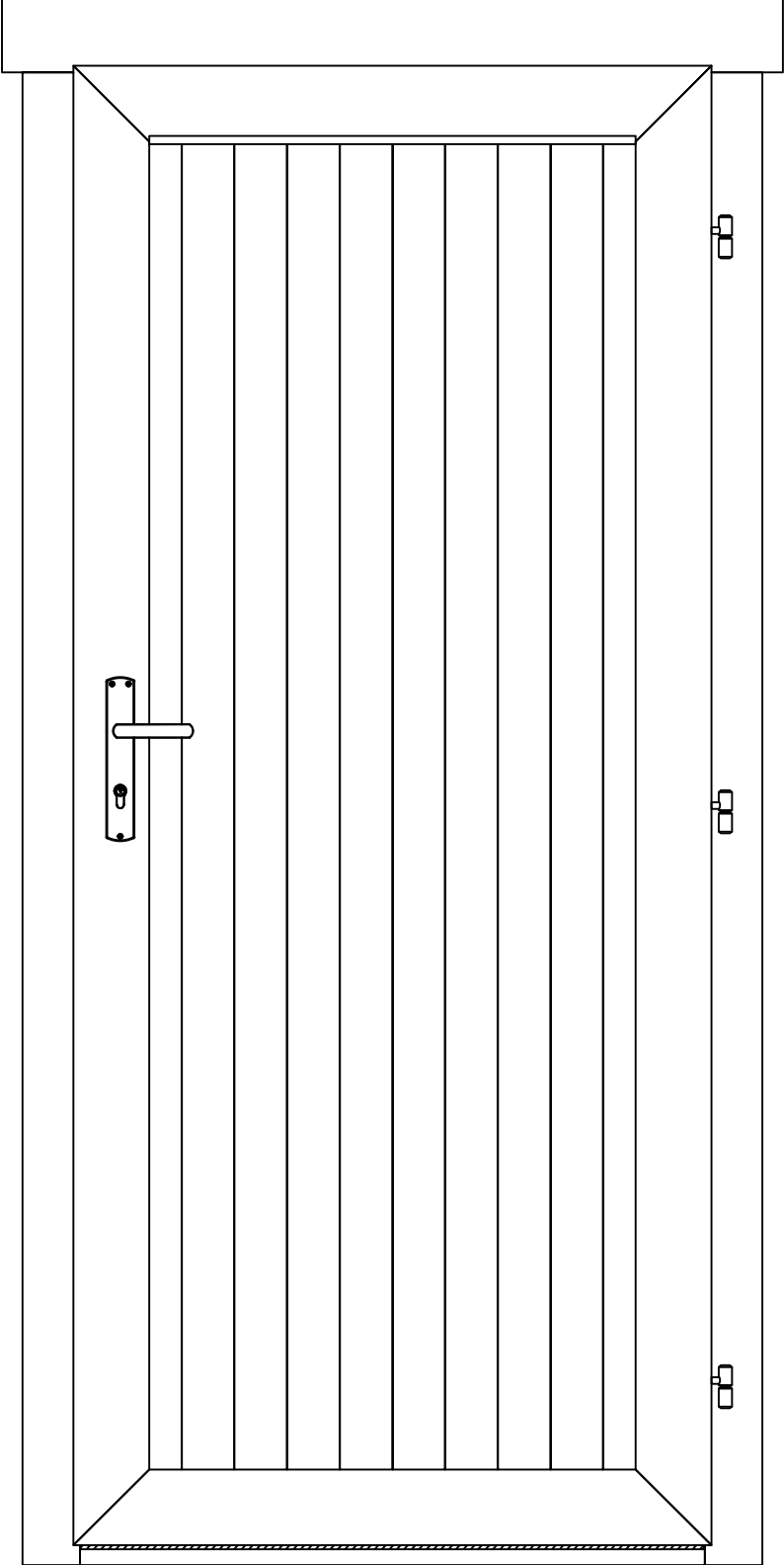
Pos	14.10.2016	Piece list - Stückliste - Liste des pièces Art. Nr. 2829600	8/8	Q	P (mm)	L (mm)
	DOOR - TÜR - PORTE 835x1850	UL.2.100.IVP.MMWa TC+0		1		
 <p>The drawing shows a door with a rectangular frame. The main panel consists of ten vertical slats. On the left side, there is a horizontal handle with a keyhole. On the right side, there are three lock bolts. The door is shown in a slightly open position, revealing the internal frame structure.</p>						