

ORKNEY 1  
Art.Nr. 704142  
1/12

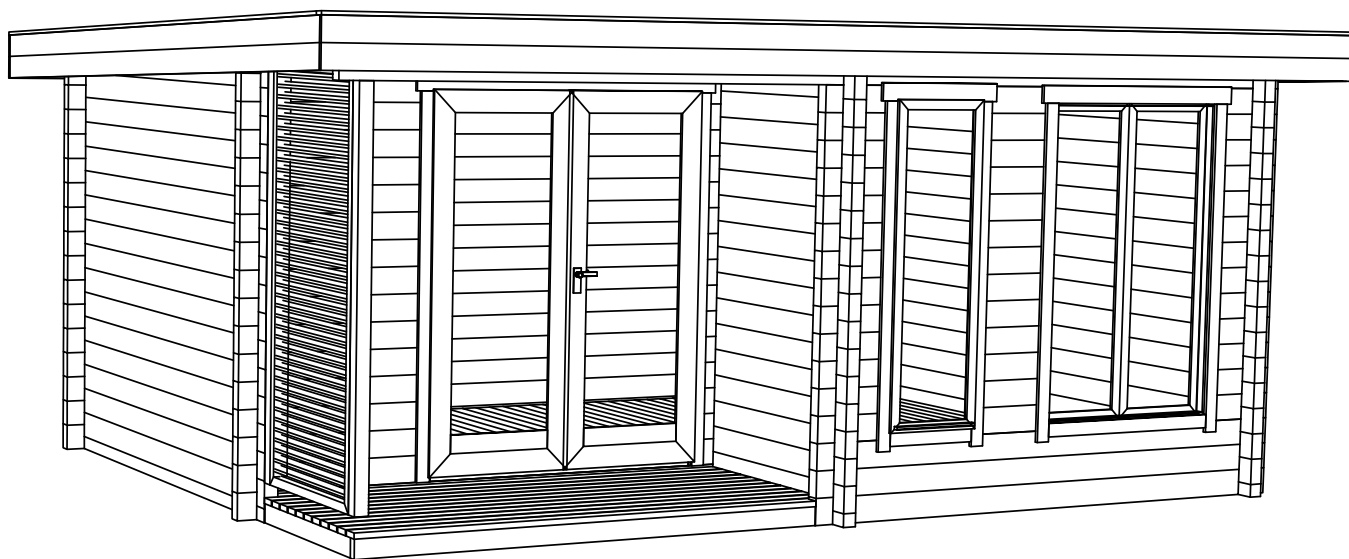

GROUNDPLAN - GRUNDPLAN - PLAN DE MASSE

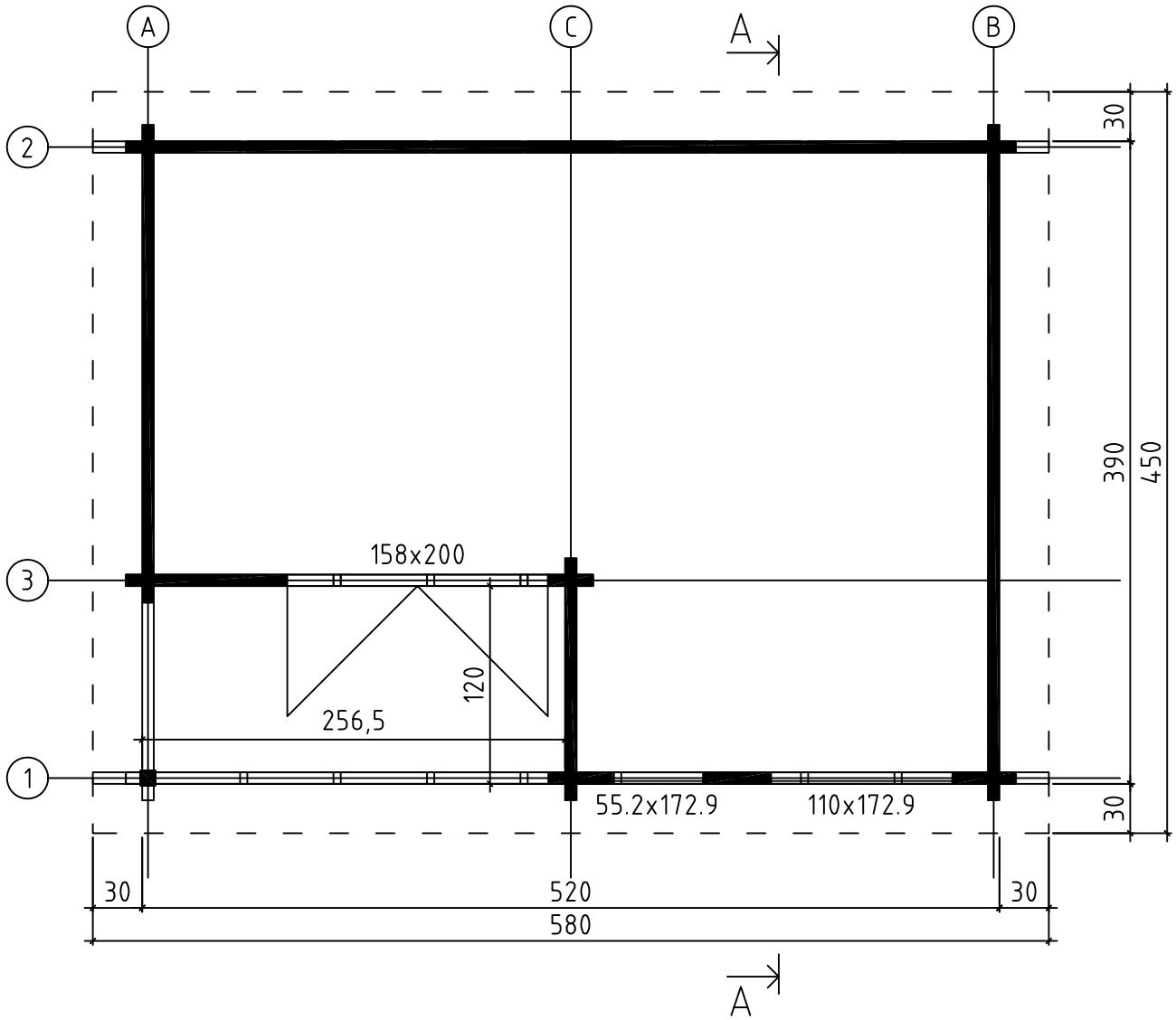

FOUNDATION - FUNDAMENT - FONDATION

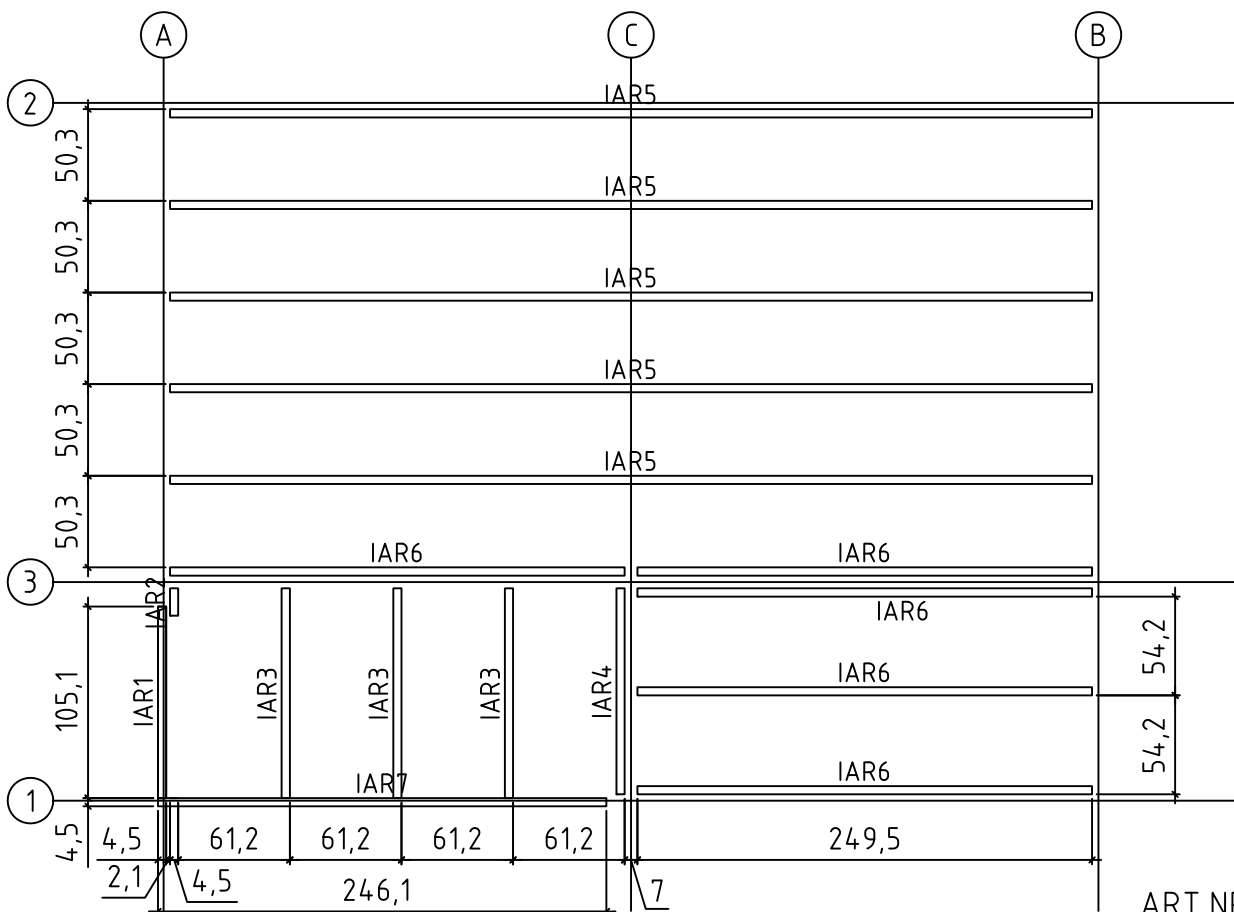

RAFTERS PLAN - DACHSPARREN - PLAN DE CHEVRON

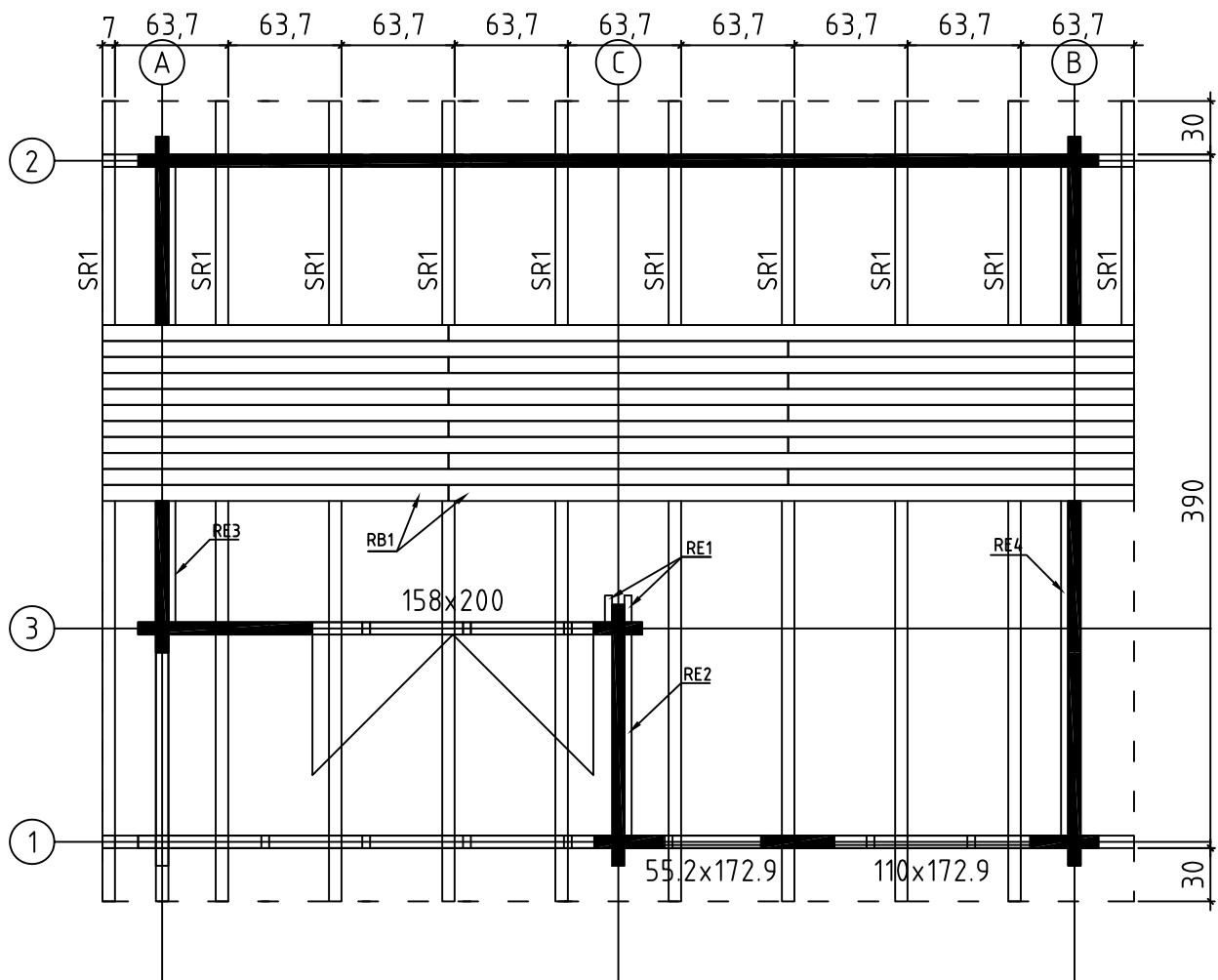

FLOOR BOARDS - FUSSBODENBRETTER - PLAN POSE PLANCHER

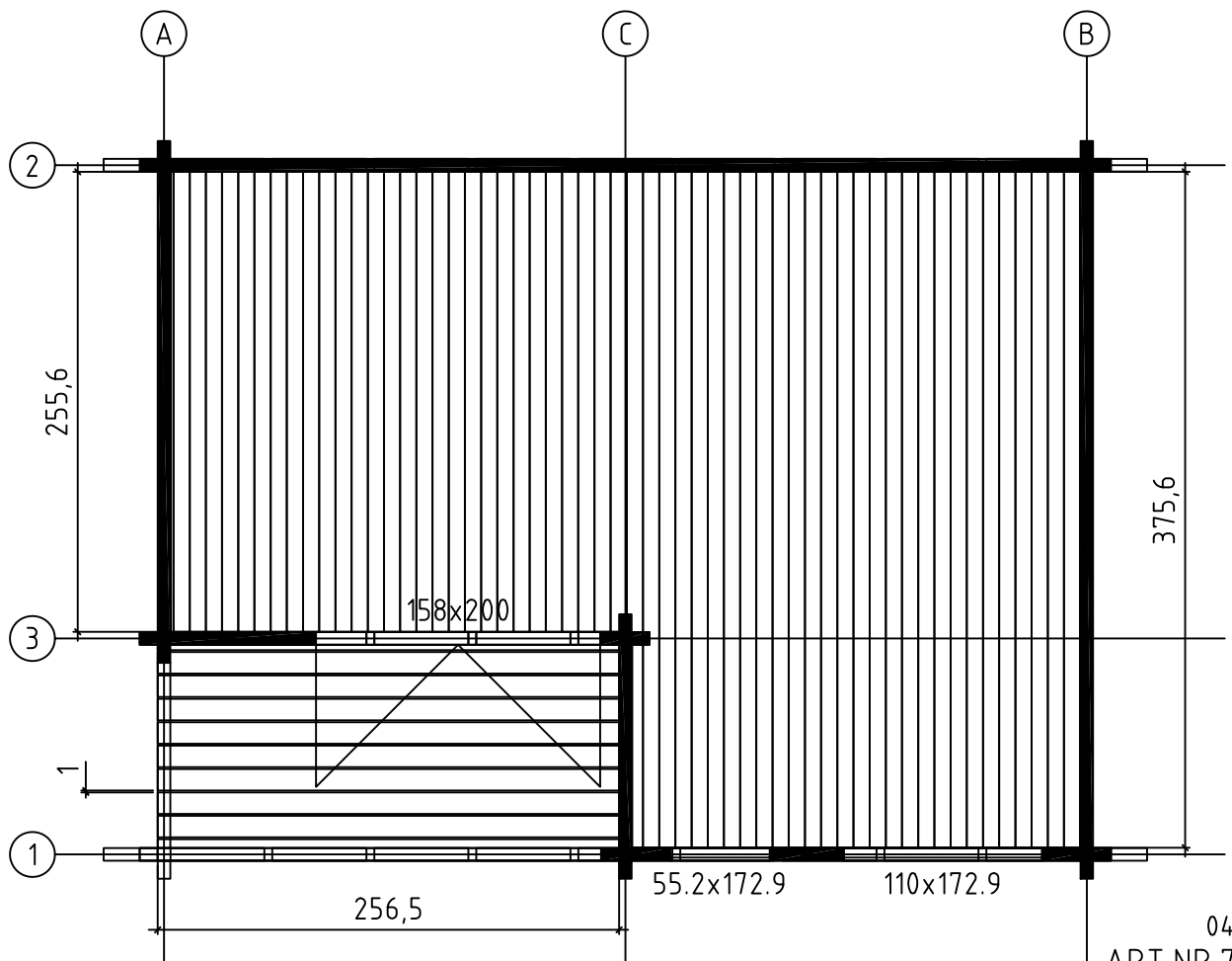

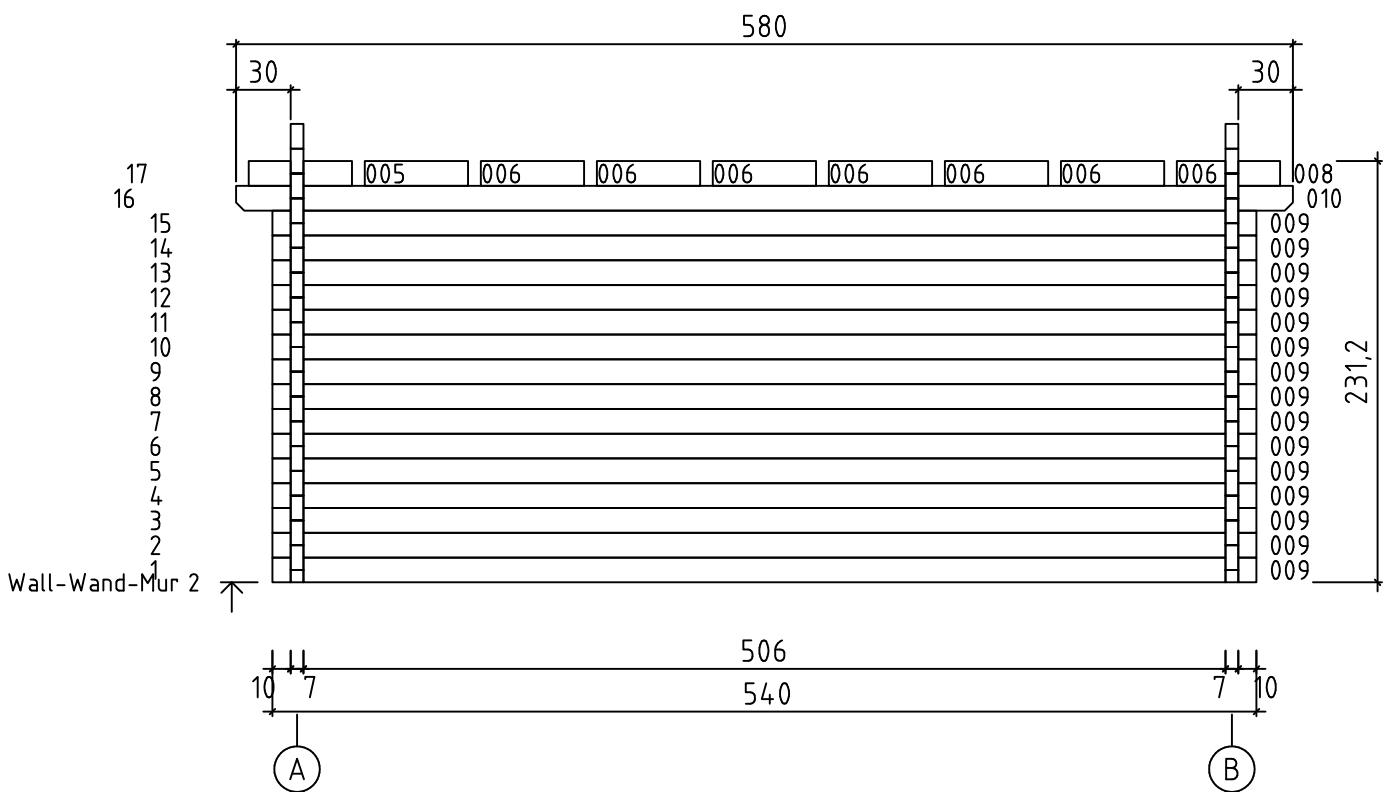
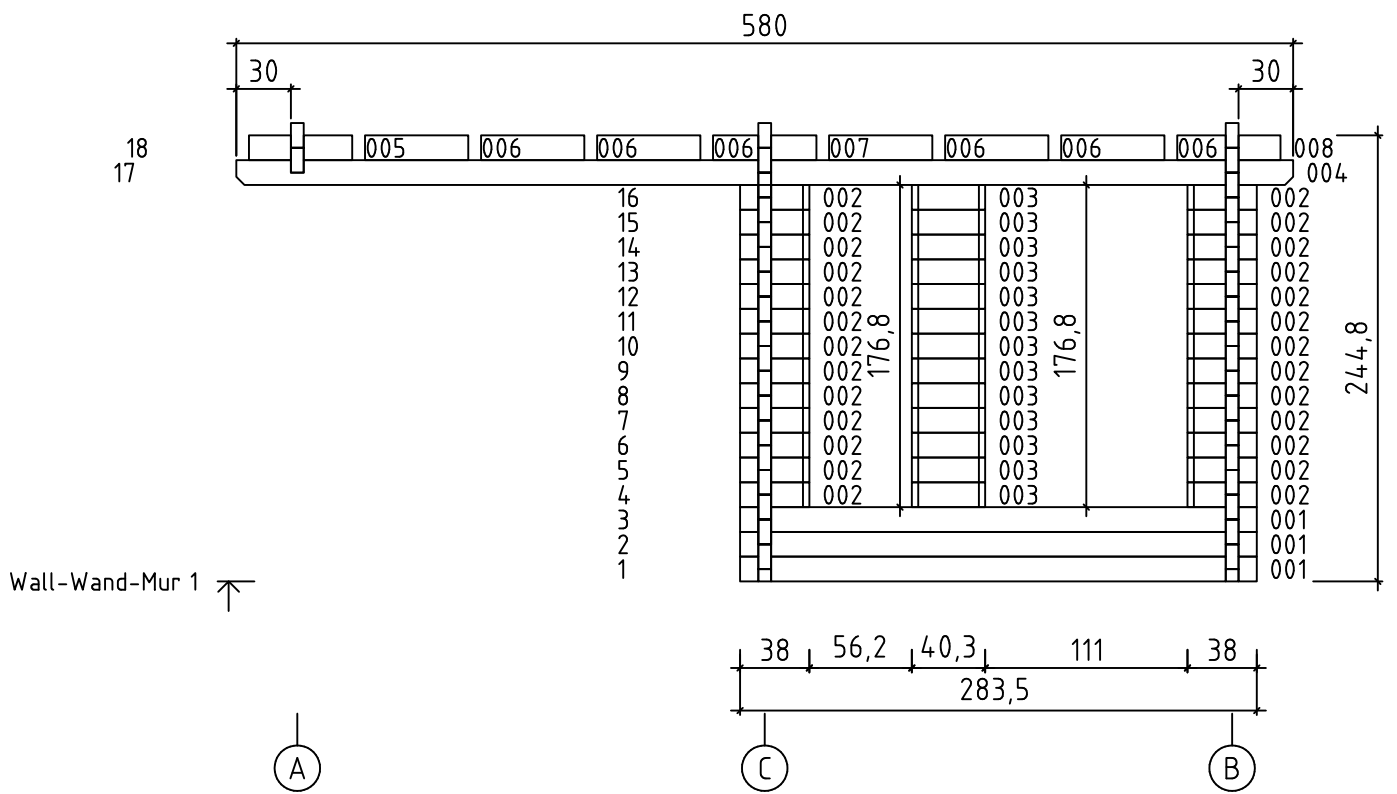

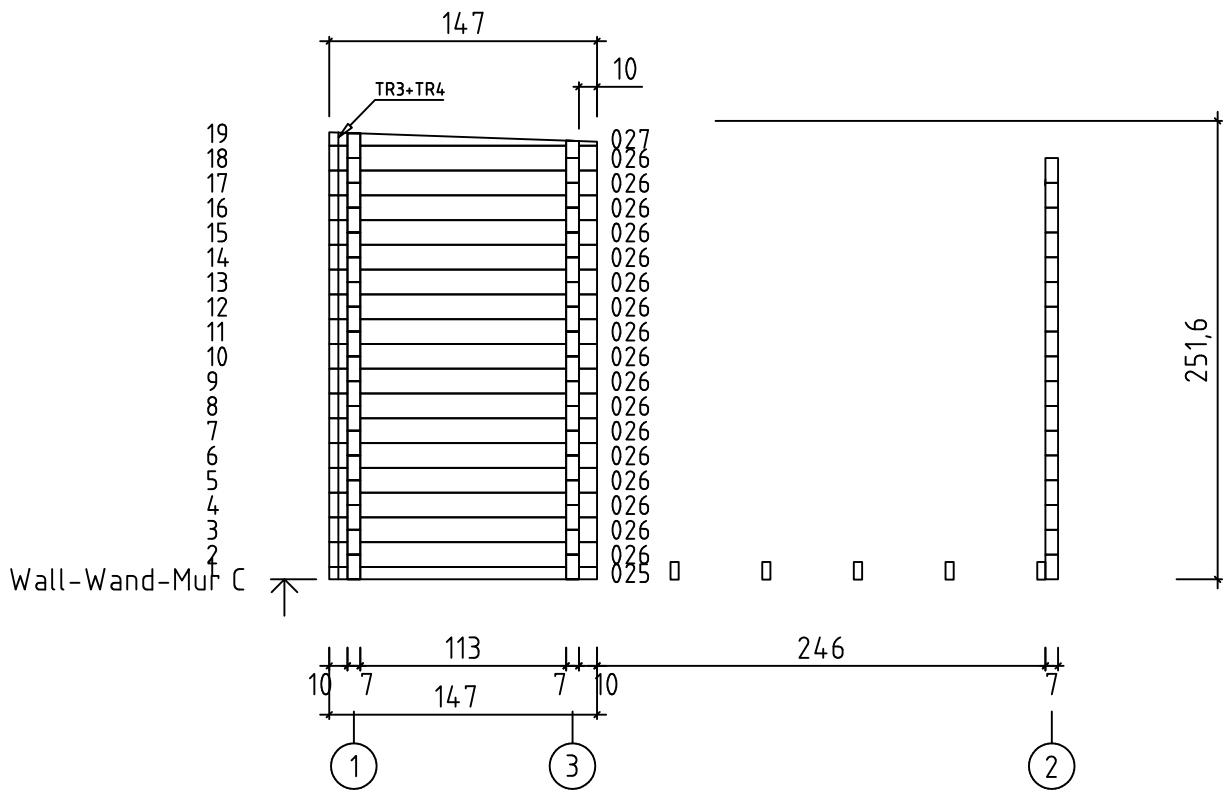
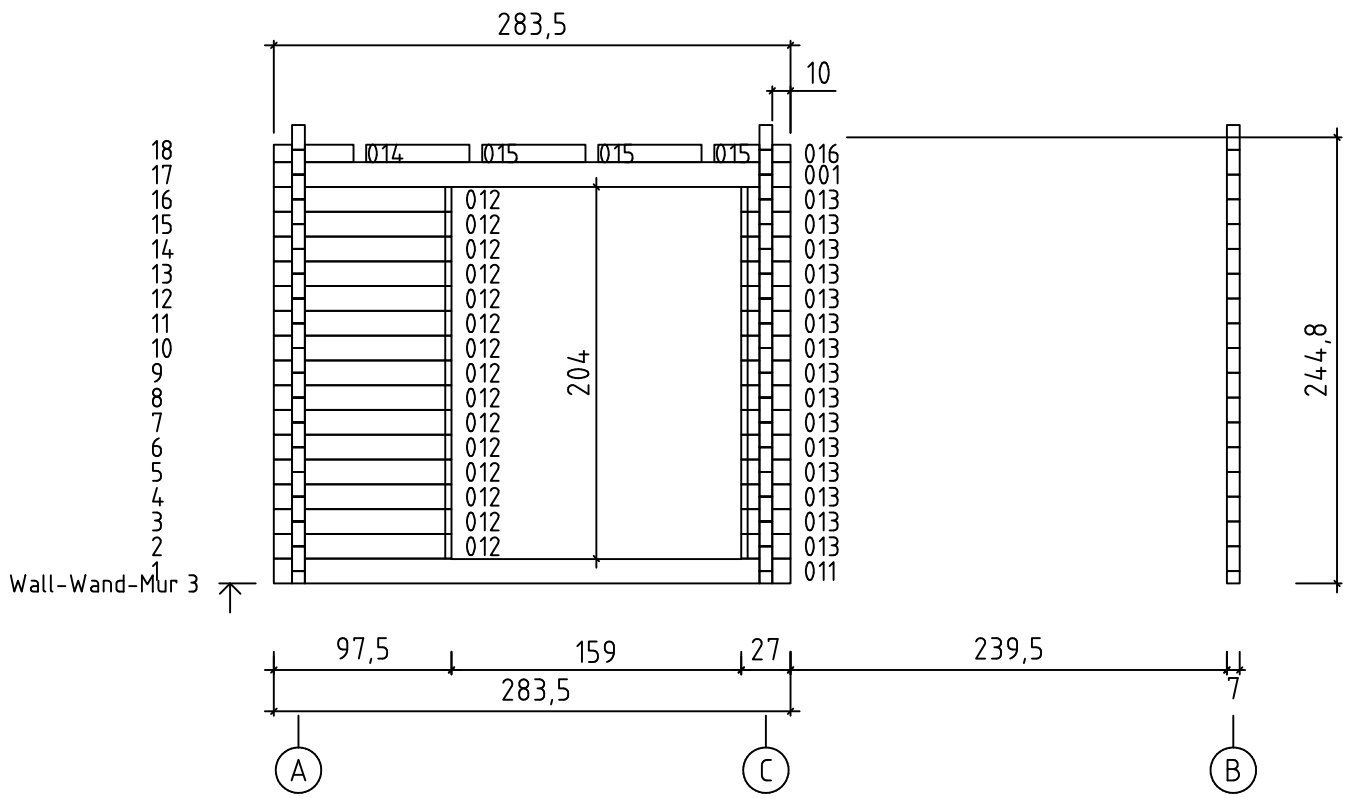

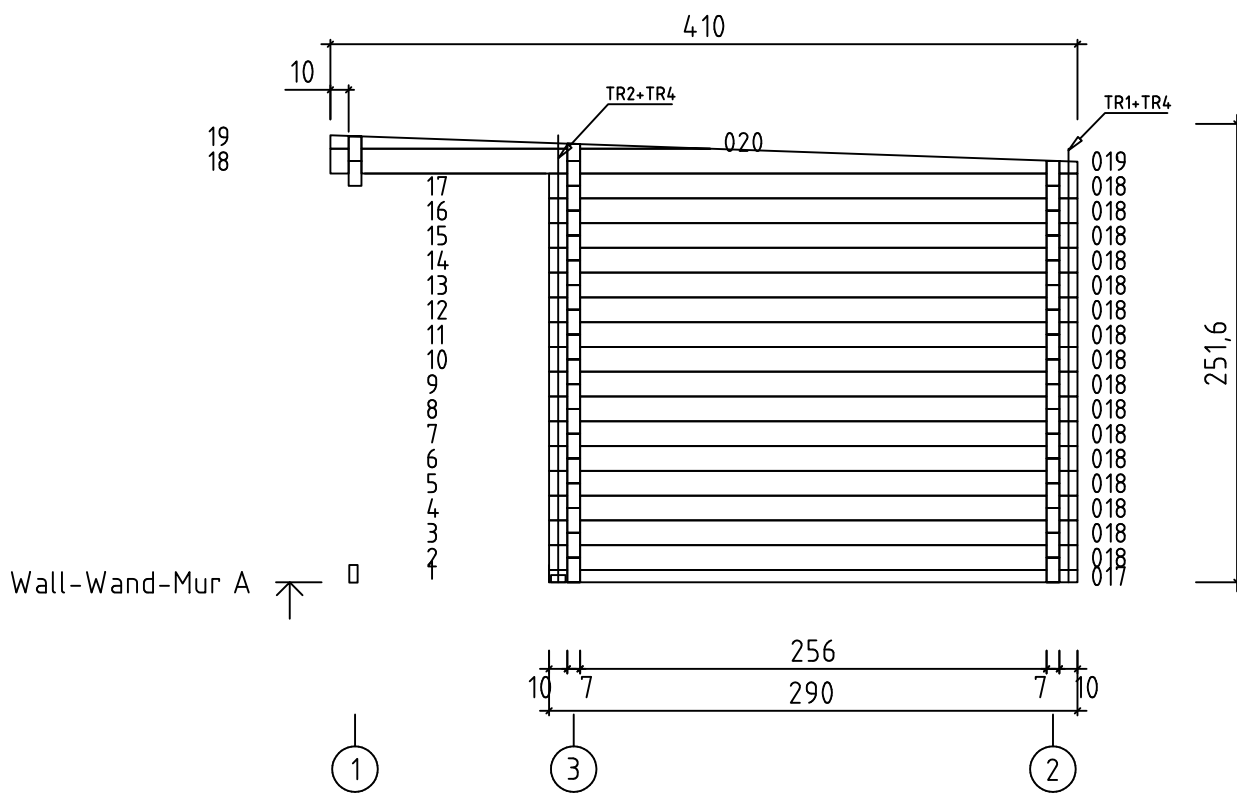
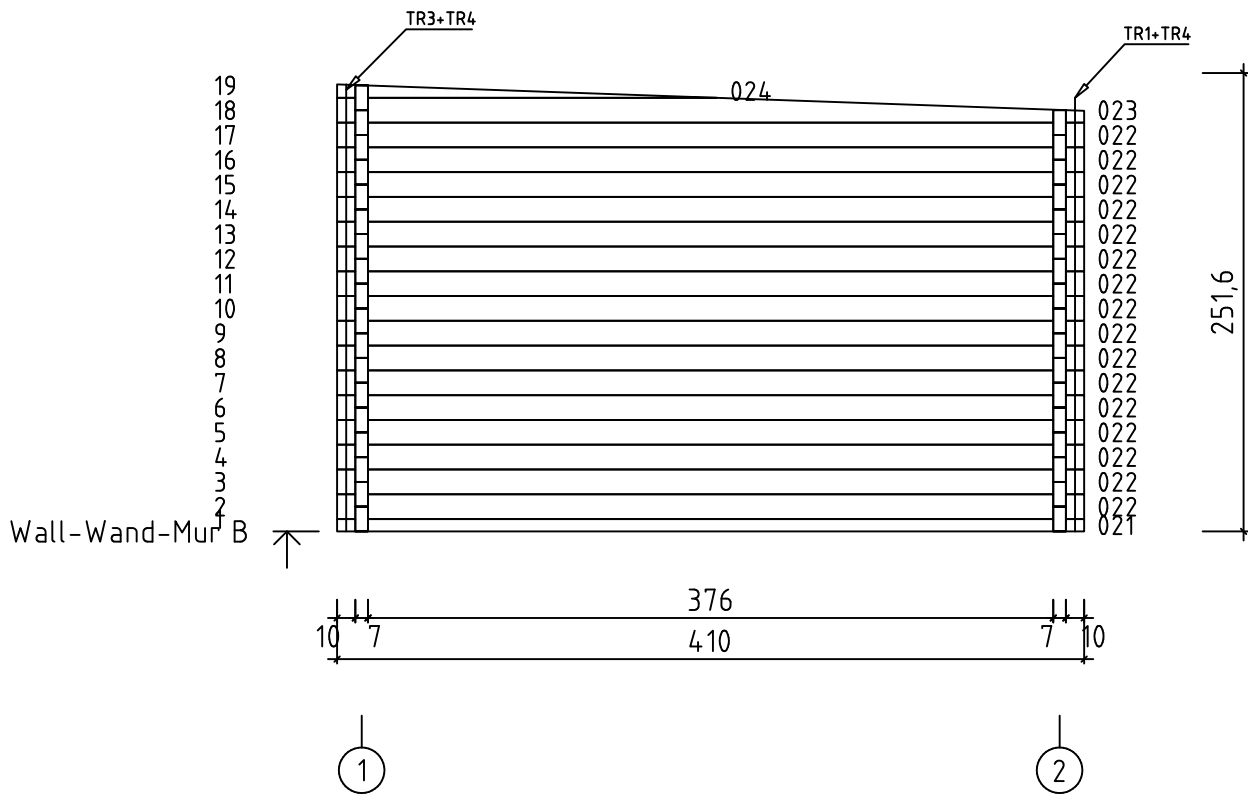

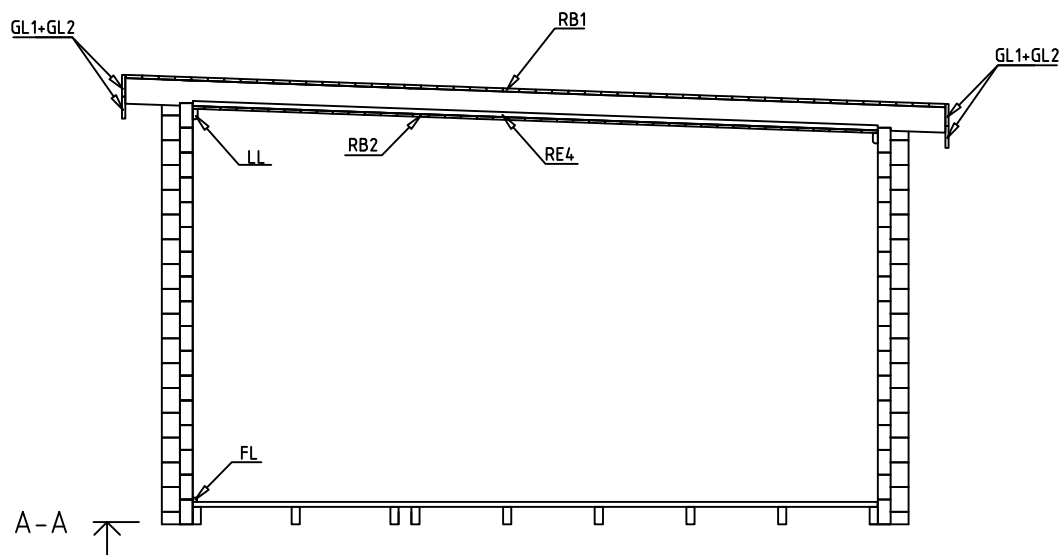
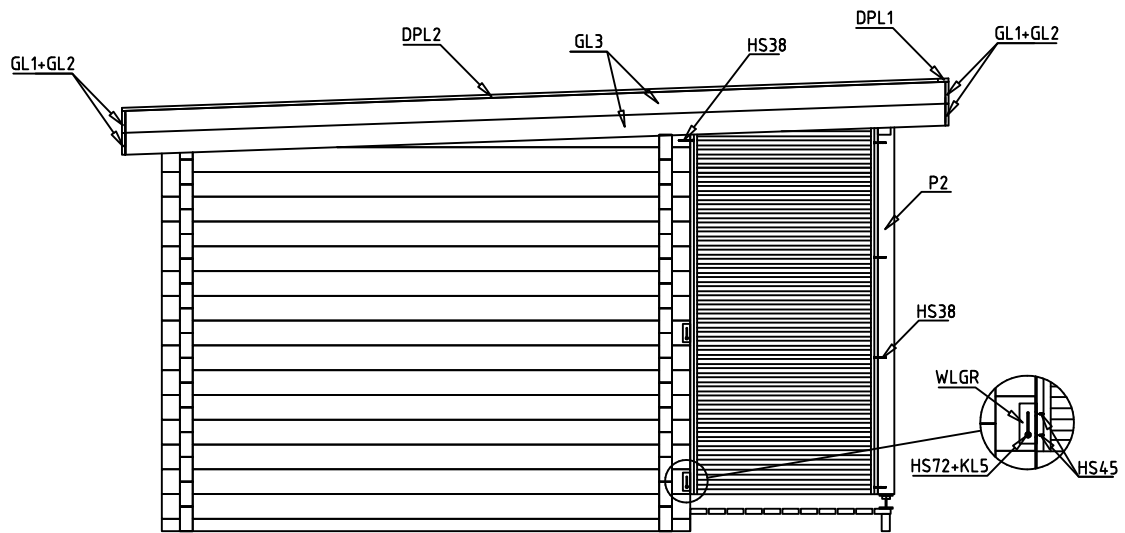
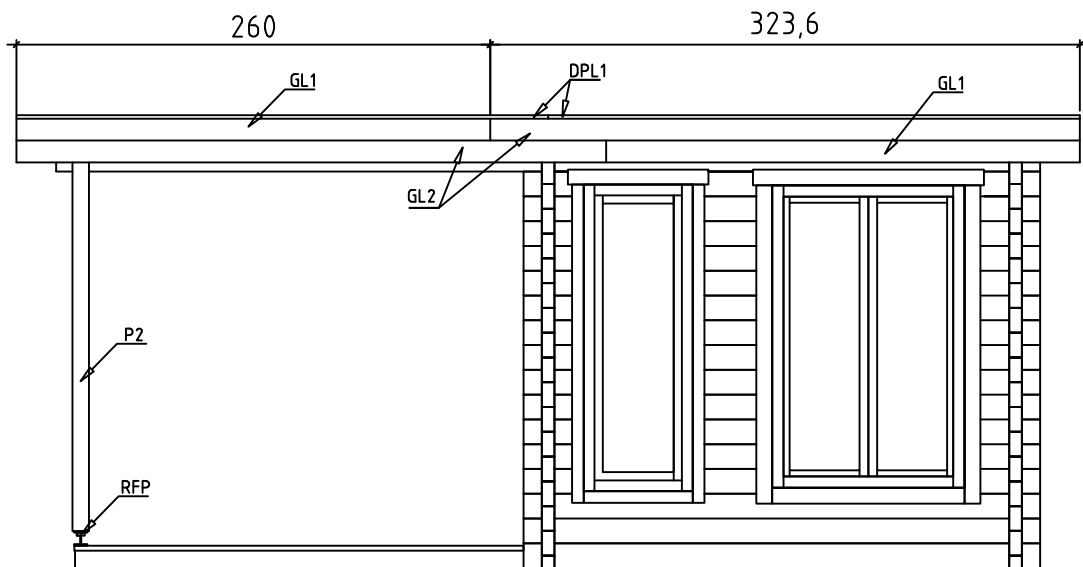

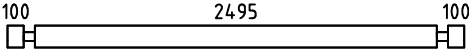

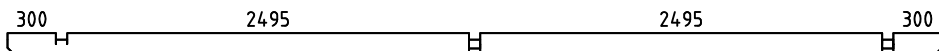



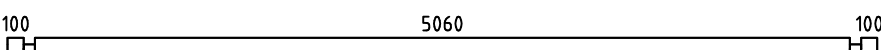
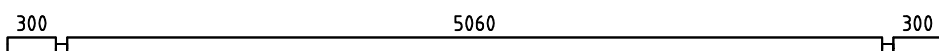
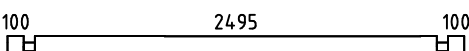
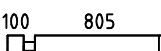



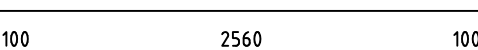
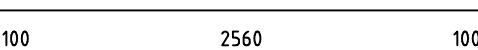
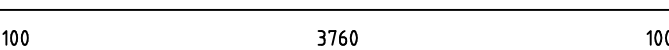
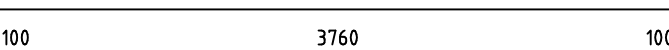
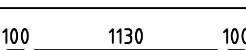
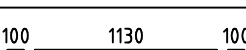
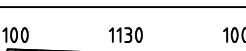
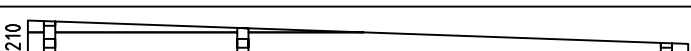
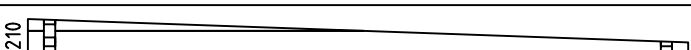



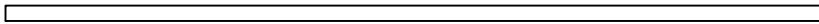
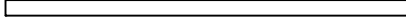
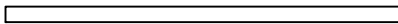
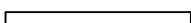



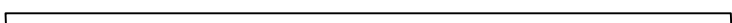
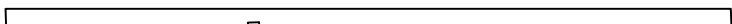
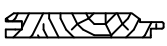













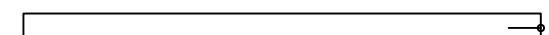



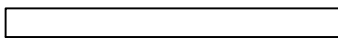
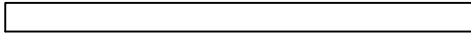
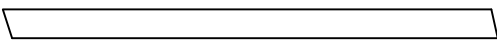

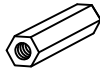

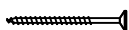
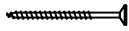
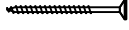
Pos	04.03.2013	ART.NR. 704142	8/12	Q.	P (mm)	L (mm)
001				4	70x136	2835
002				26	70x136	380
003				13	70x136	403
004				1	70x136	5800
005				2	70x136	567
006				13	70x136	567
007				1	70x136	567
008				2	70x136	567
009				15	70x136	5400
010				1	70x136	5800
011				1	70x136	2835
012				15	70x136	975
013				15	70x136	270
014				1	70x96	437
015				3	70x96	567
016				1	70x96	418
017				1	70x68	2900
018				16	70x136	2900
021				1	70x68	4100
022				16	70x136	4100
025				1	70x68	1470
026				17	70x136	1470
027				1	70x74	1470
WA-1				1		
WB-1				1		

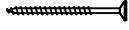

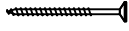
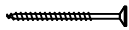
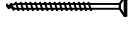
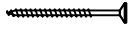
Pos	04.03.2013	ART.NR. 704142	9/12	Q.	P (mm)	L (mm)
IAR5		FOUNDATION - FUNDAMENT - FONDATION		5	45x96	5060
IAR6		FOUNDATION - FUNDAMENT - FONDATION		5	45x96	2495
IAR7		FOUNDATION - FUNDAMENT - FONDATION		1	45x96	2461
IAR3		FOUNDATION - FUNDAMENT - FONDATION		3	45x96	1151
IAR4		FOUNDATION - FUNDAMENT - FONDATION		1	45x96	1130
IAR1		FOUNDATION - FUNDAMENT - FONDATION		1	45x96	1051
IAR2		FOUNDATION - FUNDAMENT - FONDATION		1	45x96	150
SR1		RAFTER - DACHSPARREN - CHEVRON		6	70x140	4508
SR2		RAFTER - DACHSPARREN - CHEVRON		4	70x140	4508
RB2	CEILING BOARDS - DECKENBRETTER - VOLIGES SOUS PLAFOND			24	111x15	5056
RB2	CEILING BOARDS - DECKENBRETTER - VOLIGES SOUS PLAFOND			10	111x15	2491
FB	FLOOR BOARDS - FUSSBODENBRETTER - LAME DE PLANCHER			29	86x28	3756
FB	FLOOR BOARDS - FUSSBODENBRETTER - LAME DE PLANCHER			30	86x28	2556
RB1	ROOF BOARDS - DACHBRETTER - VOLIGES			51	90x18	3855
RB1	ROOF BOARDS - DACHBRETTER - VOLIGES			51	90x18	1945
	TERRACE BOARDS - TERRASSENBRETTER - PLANCHER DE TERRASSE			10	120x28	2565
FL	FLOOR FILLET-FUSSBODENLEISTE - CORNIERE DE FINITION DU PLANCHER				18x18	17.62
LL	CEILING FILLET - DECKELEISTE - PROFIL DE FINITION POUR SOUS PLAFOND				13x40	17.63
DPL1	ROOFING FELT FILLET - DACHPAPPENLEISTE - BAGUETTE DE FIXATION DU FEUTRE BITUMEUX			2	18x58	2919
DPL2	ROOFING FELT FILLET - DACHPAPPENLEISTE - BAGUETTE DE FIXATION DU FEUTRE BITUMEUX			2	18x58	4481
TR1	TREADED ROD M12 - GEWINDESTANGE M12 - TIGE FILETÉE M12			2		340
TR2	TREADED ROD M12 - GEWINDESTANGE M12 - TIGE FILETÉE M12			1		400
TR3	TREADED ROD M12 - GEWINDESTANGE M12 - TIGE FILETÉE M12			2		482
TR4	TREADED ROD M12 - GEWINDESTANGE M12 TIGE FILETÉE M12			5		2000
P2	POST - PFOSTEN - POTEAU			1	90x90	2040

Pos	04.03.2013	ART.NR. 704142	10/12	Q.	P (mm)	L (mm)
RE1	HOLDER FOR CEILING BOARDS - HALTER FÜR DECKENBRETTER - SUPPORT POUR PANNEAUX DE PLAFOND			1	44x44	150
RE2	HOLDER FOR CEILING BOARDS - HALTER FÜR DECKENBRETTER - SUPPORT POUR PANNEAUX DE PLAFOND			1	44x44	1129
RE3	HOLDER FOR CEILING BOARDS - HALTER FÜR DECKENBRETTER - SUPPORT POUR PANNEAUX DE PLAFOND			1	44x44	2560
RE4	HOLDER FOR CEILING BOARDS - HALTER FÜR DECKENBRETTER - SUPPORT POUR PANNEAUX DE PLAFOND			1	44x44	3760
GL1	GABLE MOULDING - GIEBELLEISTE PLANCHE DE RIVE			4	18x120	2600
GL2	GABLE MOULDING - GIEBELLEISTE PLANCHE DE RIVE			4	18x120	3236
GL3	GABLE MOULDING - GIEBELLEISTE PLANCHE DE RIVE			4	18x120	4504
FS	WINDOW HANDLE FITTINGS-FENSTERGRIFF - POIGNÉE D'OUVERTURE DE FENETRE			4		
TS	BOLT FOR WINDOW HANDLE FITTINGS - BOLZEN FÜR FENSTERGRIFF BESCHLAG - BOULON POUR POIGNÉE D'OUVERTURE DE FENETRE			8		
KL4	LENGTHENING BOLT FOR TREADED ROD -VERLÄNGERUNGSMUTTER FÜR GEWINDESTANGE - MANCHON DE RACCORDEMENT DE TIGE FILETÉE			5		
KL1	DRIVE NUT TREADED ROD - EINSHLAGMUTTER FÜR GEWINDESTANGE - ÉCROU A FRAPPER POUR TIGE FILITÉE			5		
KL2	NUT FOR TREADED ROD - MUTTER FÜR GEWINDESTANGE - ÉCROU POUR TIGE FILETÉE			5		
KL3	PLAIN WASHER TREADED ROD - UNTERLEGSSCHEIBE FÜR GEWINDESTANGE - RONDELLE PLATE POUR TIGE FILETÉE			5		
HS16	SCREW FOR GABLE MOULDING - SCHRAUBEN FÜR GIEBELLEISTE - VIS DE FIXATION POUR PLANCHE DE RIVE			110	3.5x50	
HS38	SCREW FOR FIXING TERRACE RAILING - SCHRAUBE FÜR TERRASSE VIS DE FIXATION DE GARDE-CORPS DE TERRASSE			5	4.5x80	
HS37	SCREW FOR POST - SCHRAUBEN FÜR PFOSTEN - VIS DE FIXATION DES POTEAUX			2	4.5x80	
HS45	SCREW FOR SLIDING WALL TIE - SCHRAUBEN FÜR WAND SCHIEBEREGLER -			8	4x20	
NFD	SCREW FOR ROOFING FELT FILLET - SCHRAUBEN FÜR DACHPAPPENLEISTE - VIS POUR BAGUETTE FIXATION FEUTRE BITUMEUX			34	4x40	
HS43	SCREW FOR ROOF BEAMS - SCHRAUBEN FÜR DACHBALKEN - VIS POUR PANNE DE TOIT			24	5x120	
	SCREW FOR GABLE - SCHRAUBEN FÜR GIEBEL - VIS POUR FIXATION DES PIGNONS			8	5x120	
HS39	SCREW FOR FUNDAMENT - SCHRAUBEN ZUR BEFESTIGUNG FUNDAMENT - VIS POUR FONDATION			39	5x90	
HS81	SCREW FOR CEILING BOARD HOLDER - SCHRAUBE FÜR HALTER FÜR DECKENBRETTER HALTER - VIS DE FIXATION SUPPORT POUR PANNEAUX DE PLAFOND			26	5x90	
HS48	SCREW FOR Pos. 005-008; 014-016 - SCHRAUBEN FÜR für Pos. 005-008; 014-016 VIS POUR FIXATION DERNIÈRE RANGÉE MADRIERS (MURS AVANT ET ARRIÈRE)			46	6x180	
HS49	SCREW FOR POST HEIGHT ADJUSTMENT - SCHRAUBEN FÜR REGULIERUNGSSCHRAUBE FÜR PFOSTEN - VIS DE FIXATION DE SUPPORT RÉGLABLE DE POTEAU			8	6x50	
HS72	SCREW FOR SLIDING WALL TIE - SCHRAUBEN FÜR WAND SCHIEBEREGLER -			2	5x60	

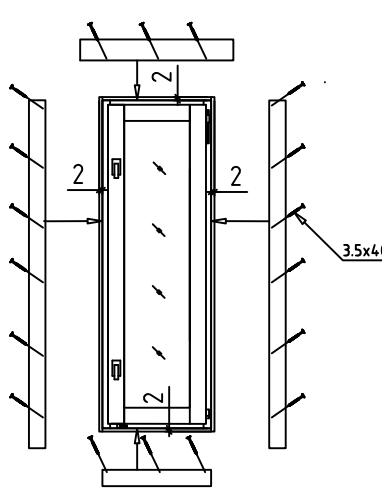
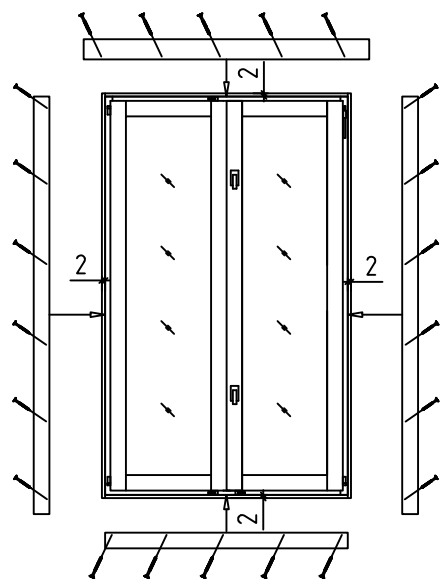
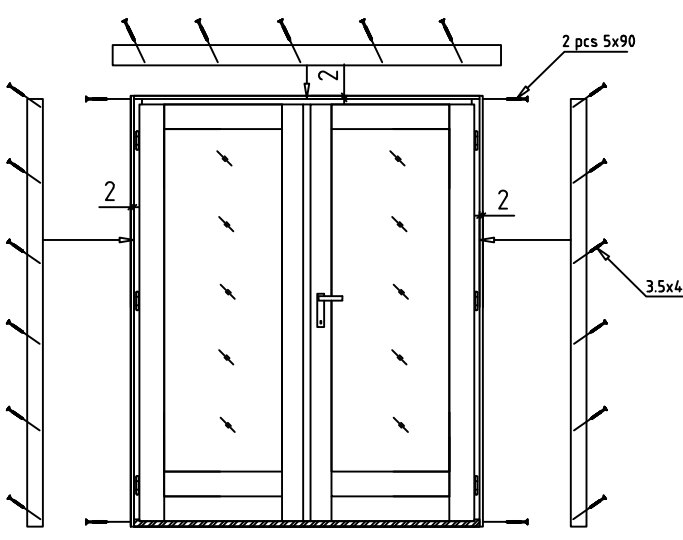

Pos	04.03.2013	ART.NR. 704142	12/12	Q.	P (mm)	L (mm)
AK.1.10 0.PSP.7	<p style="text-align: center;">WINDOW-FENSTER-FENETRE 552x1729</p> 			1		
TAK.1 100. PSVP.7	<p style="text-align: center;">WINDOW-FENSTER-FENETRE 1100x1729</p> 			1		
TUK.1 100.PV P.MM7b	<p style="text-align: center;">DOOR-TÜR-PORTE 1580x2000</p> 			1		